



**METRO
ALUMINUM**

Products Ltd.

2300 SERIES

DOUBLE GLAZING STOREFRONT SYSTEM
2" X 3 1/4" (50.8mm X 82.6mm)

C



Part 1 - GENERAL

Scope - The storefront framing system shall be _____ Series as manufactured by METRO ALUMINUM Products Ltd. Supply and install aluminum framing, as described on the architectural drawings and as specified herein.

Work Not Included - See: Specifier's lists of excluded items; Items furnished but not installed and/or Items installed but not furnished.

Related Work Specified Elsewhere - See: Specifier's lists and related Sections.

Design & Performance Requirements - Framing to fully comply with applicable standard specifications as typically referenced to the following performance requirements criteria: Air Tightness, Water Tightness, Wind and Other Load resistance, Temperature Index and Energy Performance. (Specifier's selection)

Submittals - Shop Drawings & Samples - Submit all documentation and samples for review by Consultant at one time, prior to fabrication of door products.

Quality Assurance - Provide all necessary information to show that all involved products meet or exceed the requirements of these specifications.

Delivery, Storage and Handling - Deliver, store, handle, protect and schedule materials and products so as to avoid any damage. Follow recommendations of AAMA CW-10 "Care and Handling of Architectural Aluminum from Shop to Site" and others as applicable.

Part 2 - PRODUCTS

Materials - All materials to meet the applicable minimum design and specifications requirements. Any defects impairing strength, durability or appearance are not acceptable. Extruded aluminum shall be AA 6063 T6 alloy and temper - Fy = 110 MPa (16 KSI) minimum. Sufficient strength and size fasteners shall be made of corrosion-resistant and compatible material such as cadmium or zinc plated carbon steel, stainless steel or aluminum, to prevent any galvanic action (electrolytic corrosion). Standard gaskets shall be extruded from dense Neoprene, EPDM, or other equal material. Gasket profiles, for dry-dry, outside-flush glazing method, shall be designed and sized to fit tight and properly seal glass-metal interfacing. Glass setting to be compatible with glass unit seals and/or other parts involved as required.

System Description - Framing System shall be 1750, 2000, 2050, 1300, 2300 - non-thermally broken/uninsulated (thermally broken/insulated - T), for single glass (sealed insulating glass units) METRO Series - Specifier selection - as manufactured by METRO ALUMINUM Products Ltd.

Reference dimensions of extruded profiles shall be:
1750 - 1.75" (44.5 mm) x 4.5" (114.3 mm) - 0.5" (12.7 mm) GP - NTB
2100 - 2" (50.8 mm) x 4.5" (114.3 mm) - 1.25" (37.7 mm) GP - TB
2050 - 2" (50.8 mm) x 4.5" (114.3 mm) - 1.25" (37.7 mm) GP - TB

1300 - 1.75" (44.5 mm) x 3.25" (82.6 mm) - 0.5" (12.7 mm)

GP - NTB

2300 - 2" (50.8 mm) x 3.25" (82.6 mm) - 1.25" (37.7 mm) GP - NTB

2300T - 2" (50.8 mm) x 3.25" (82.6 mm) - 1.25" (37.7 mm) GP - TB

Glass retention, as for dry-flush glazing method, shall be achieved by 3-side fixed pockets and a sill glazing stop profile and inorganic rubber gasket. Where applicable, thermal break shall be polyurethane poured-in resin type.

Whenever substitute/alternative products are considered, supporting data to be submitted ten (10) days prior to bid date to allow for valid comparison. Approval of alternates to be confirmed in advance of bid closing by addendum only.

Fabrication - Extruded profiles shall be accurately fabricated and assembled to provide tight fit hairline joints only. Corner joinery shall utilize concealed assembly screws or spigots. Parts involved shall be fastened by means of anticorrosive steel screws to allow for permanent true and square set of frame elements. Frame assemblies shall be free of warp. Uniformly compressed glazing gaskets shall secure glass in place. No exposed fasteners are permitted.

Finish - All exposed surfaces shall be finished as specified. The finish, as per AAM designation, shall be (Specifier's selection):

Standard clear anodizing to AA - M12C22A31

Standard perma bronze to AA - M12C22A44

Standard black anodized to AA - M10C21A44

Duracron acrylic enamel to AA - M12C4XR1X

Custom paint qualities and colors - Specifier's selection.

Hardware to have manufacturer's standard finish.

Part 3 - EXECUTION

Installation - Extruded subsills, completed with integrated end dams, to be set and sealed as required. Prefabricated framing to be installed in prepared openings, at correct locations as shown on drawings, set level, plumb, square and aligned with other work in accordance with manufacturer's instructions, approved shop and erection drawings.

Anchoring shall suit perimeter conditions of rough openings and seals as required. Perimeter joints to be sealed/caulked as specified and detailed to ensure weathertight assembly.

Protection and Cleaning - Work to be protected from damage during and after installation. Consult with manufacturer and installer to determine appropriate protective measures. The General Contractor shall be responsible for protection during construction and for final cleaning. After installation, aluminum work and glass to be cleaned according to instructions/manuals provided by product manufacturers and glaziers. Use appropriate cleaning materials and methods. Do not scratch or damage glass or finishes.



**METRO
ALUMINUM**

Products Ltd.

2300 SERIES

DOUBLE GLAZING STOREFRONT SYSTEM
2" X 3 1/4" (50.8mm X 82.6mm)

**C
05**

COMPONENTS

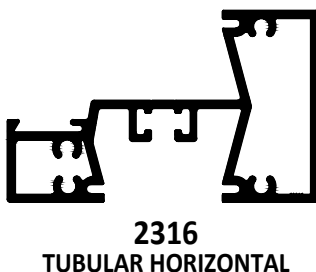
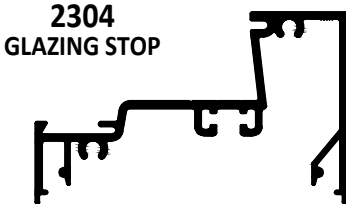
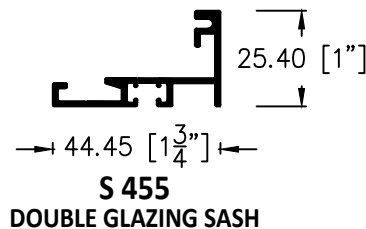
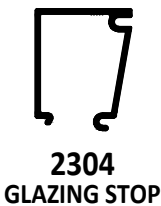
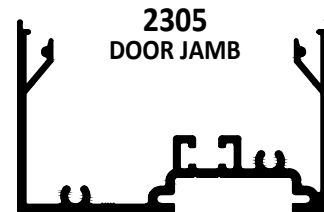
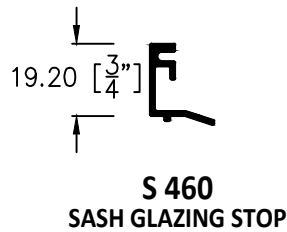
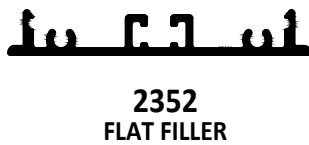
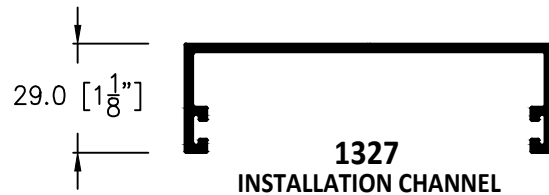
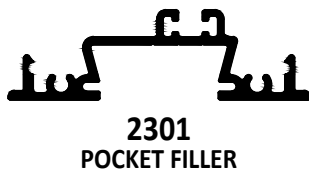
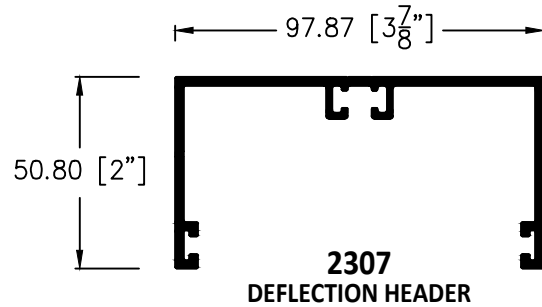
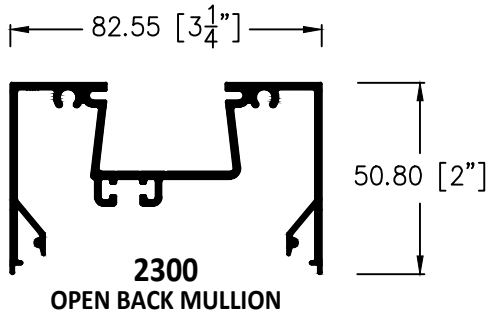

6" THRESHOLDS FOR
4 1/2" SYSTEM

1506



1506T



2106 BEVELLED



2106T SQUARE



2107T SQUARE

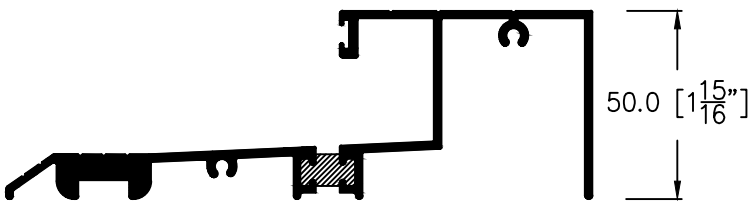

5" THRESHOLDS FOR
3 1/4" SYSTEM

1306



1306T



2306 BEVELLED

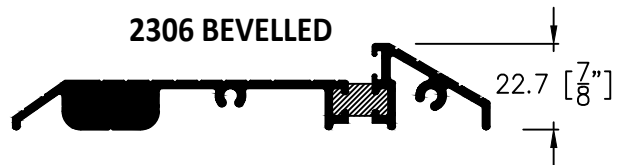

2306T SQUARE

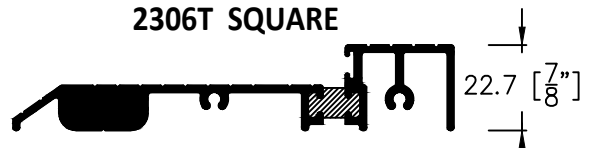

G-2306ST SQUARE

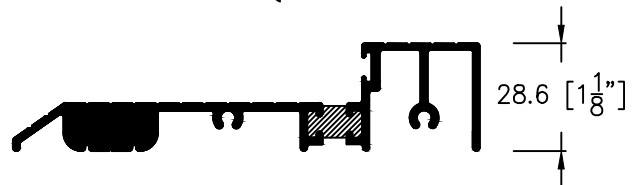

1507

7" THRESHOLDS

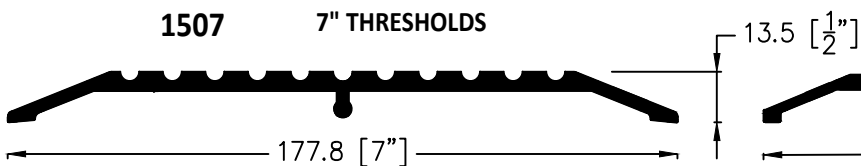

1508

8" THRESHOLDS

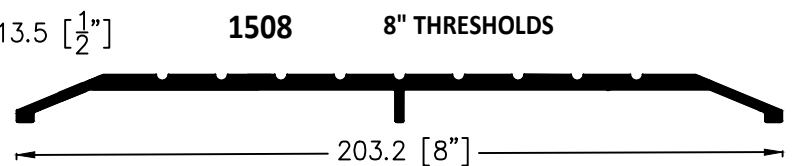



**METRO
ALUMINUM**
Products Ltd.

2300 SERIES
DOUBLE GLAZING STOREFRONT SYSTEM
2" X 3 1/4" (50.8mm X 82.6mm)

**C
06**

TYPICAL DETAILS

