

Part 1 - GENERAL

Scope - The doors shall be _____ as manufactured by METRO ALUMINUM Products Ltd. Supply and install aluminum doors, as described on the architectural drawings and as specified herein.

Work Not Included - See: Specifier's lists of excluded items; Items furnished but not installed and/or Items installed but not furnished.

Related Work Specified Elsewhere - See: Specifier's lists and related Sections.

Design & Performance Requirements - Doors to fully comply with applicable standard specifications as typically referenced to the following performance requirements criteria: Air Tightness, Water Tightness, Wind and Other Load resistance, Temperature Index and Energy Performance. (Specifier's selection)

Submittals - Shop Drawings & Samples - Submit all documentation and samples for review by Consultant at one time, prior to fabrication of door products.

Quality Assurance - Provide all necessary information to show that all involved products meet or exceed the requirements of these specifications.

Delivery, Storage and Handling - Deliver, store, handle, protect and schedule materials and products so as to avoid any damage. Follow recommendations of AAMA CW-10 "Care and Handling of Architectural Aluminum from Shop to Site" and others as applicable.

Part 2 - PRODUCTS

Materials - All materials to meet the minimum design and materials specifications as applicable. Any defects impairing strength, durability or appearance are not acceptable. Extruded aluminum shall be AA 6063 T6 alloy and temper - Fy = 110 MPa (16 KSI) minimum.

Sufficient strength and size fasteners shall be made of corrosion-resistant and compatible material such as cadmium or zinc plated carbon steel, stainless steel or aluminum, to prevent any galvanic action (electrolytic corrosion). Standard weathering at perimeter frame shall be pile cloth with a vinyl fin - minimum, or an extruded thermoplastic elastomer tubular profile with a semirigid setting key (Specifier's selection). Optional weathering at the bottom rail shall be a sweep blade type strip secured with concealed fasteners. Dry glazing method to utilize extruded dense Neoprene, EPDM, or other equal material; spline (and/or wedge) gaskets set into extruded aluminum stops. Gasket profile shall be designed and sized to fit tight and properly seal glass-metal interfacing. Glass setting to be compatible with glass unit seals and/or other parts involved as required.

System Description - Door System shall be type out-swing/in-swing _____. METRO Series for single glass (for sealed insulating glass units), uninsulated (insulated) - Specifier selection - as manufactured by METRO ALUMINUM Products Ltd.

Reference minimum thickness of extruded metal shall be: Frame 3 mm (0.12") and Glazing Stop 1.3 mm (0.05") minimum.

Frame nominal dimensions of extruded metal shall be:

Depth of frame	_____
Width of stile	_____
Height of top rail	_____
Height of middle rail	_____
Height of bottom rail	_____

Glass retention, as for dry glazing method, shall be achieved by extruded aluminum glazing stop profile and inorganic rubber gasket. Whenever substitute/alternative products are considered, supporting data to be submitted ten (10) days prior to bid date to allow for valid comparison. Approval of alternates to be confirmed in advance of bid closing by addendum only.

Fabrication - Tubular profiles of rails and stiles shall be accurately fabricated and assembled to provide tight fit hairline joints only. Corner joinery shall utilize assembly spigot-bracket. Parts involved shall be fastened by means of anticorrosive steel screws and bolts with additional securing welds to allow for permanent true and square set of frame elements. Extruded aluminum square glazing stops, equipped with hollow gaskets, shall secure glass on both sides. Specified hardware shall be connected accurately to aluminum framing as per manufacturer's specifications. No exposed fasteners are permitted. Each door leaf to be equipped with adjusting mechanism, set at the top rail, to allow for necessary installation adjustments. Both stiles of centre hung single door, hinge and meeting stile (1) sides of centre hung pair doors shall be furnished with hard-backed poly pile weather-stripping, as required. Perimeter frame of offset pivoted (or butt hung) doors to have weather-strip stops at jamb and head. Active meeting stiles of pairs to be furnished with matching weather-strip device set and secured in appropriate reveal-groove. Bottom rail to receive weather-strip sweep as required.

Finish - All exposed surfaces shall be finished as specified. The finish, as per AAM designation, shall be (Specifier's selection):

Standard clear anodizing to AA - M12C22A31
Standard perma bronze to AA - M12C22A44
Standard black anodizing to AA - M10C21A44
Duracron acrylic enamel to AA - M12C4XR1X
Custom paint qualities and colors - Specifier's selection.
Hardware to have manufacturer's standard finish.

Hardware - Hardware shall be supplied by METRO ALUMINUM Products Ltd. for factory installation, and to include: (Specifier's selection):

Top and bottom offset pivots.
Intermediate offset pivots where required, or
1 pair or 1.5 pairs of 100 mm x115 mm (4" x 4.5") butt hinges, or
Centre hung pivots compatible with centre hung closers.
Push-pull - Metro standard.
Door closers - streamline or concealed.
Standard 150 mm (6") threshold with reinforced pivot anchor point.
Panic device. Various types available - Specifier's selection.
Alternative hardware clause: Hardware as specified under separate section of the Specifications. The manufacturer shall furnish all necessary templates for assembly and installation.

Part 3 - EXECUTION

Installation - Doors to be installed in prepared openings, at correct locations as shown on drawings, set level, plumb, square and aligned with other work in accordance with manufacturer's instructions, approved shop and erection drawings. Operating hardware, checked and adjusted as required, shall be left in ready for use condition. Perimeter joints to be sealed/caulked as specified and detailed to ensure weathertight assembly.

Protection and Cleaning - Work to be protected from damage during and after installation. Consult with manufacturer and installer to determine appropriate protective measures. The General Contractor shall be responsible for protection during construction and for final cleaning. After installation, aluminum work and glass to be cleaned according to instructions/manuals provided by product manufacturers and glaziers. Use appropriate cleaning materials and methods. Do not scratch or damage glass or finishes.

Note: The above Specifications should relate to The Product Specifications by METRO ALUMINUM Products Ltd. as applicable to the specific door types such as: 250, 350 and 500 Series.

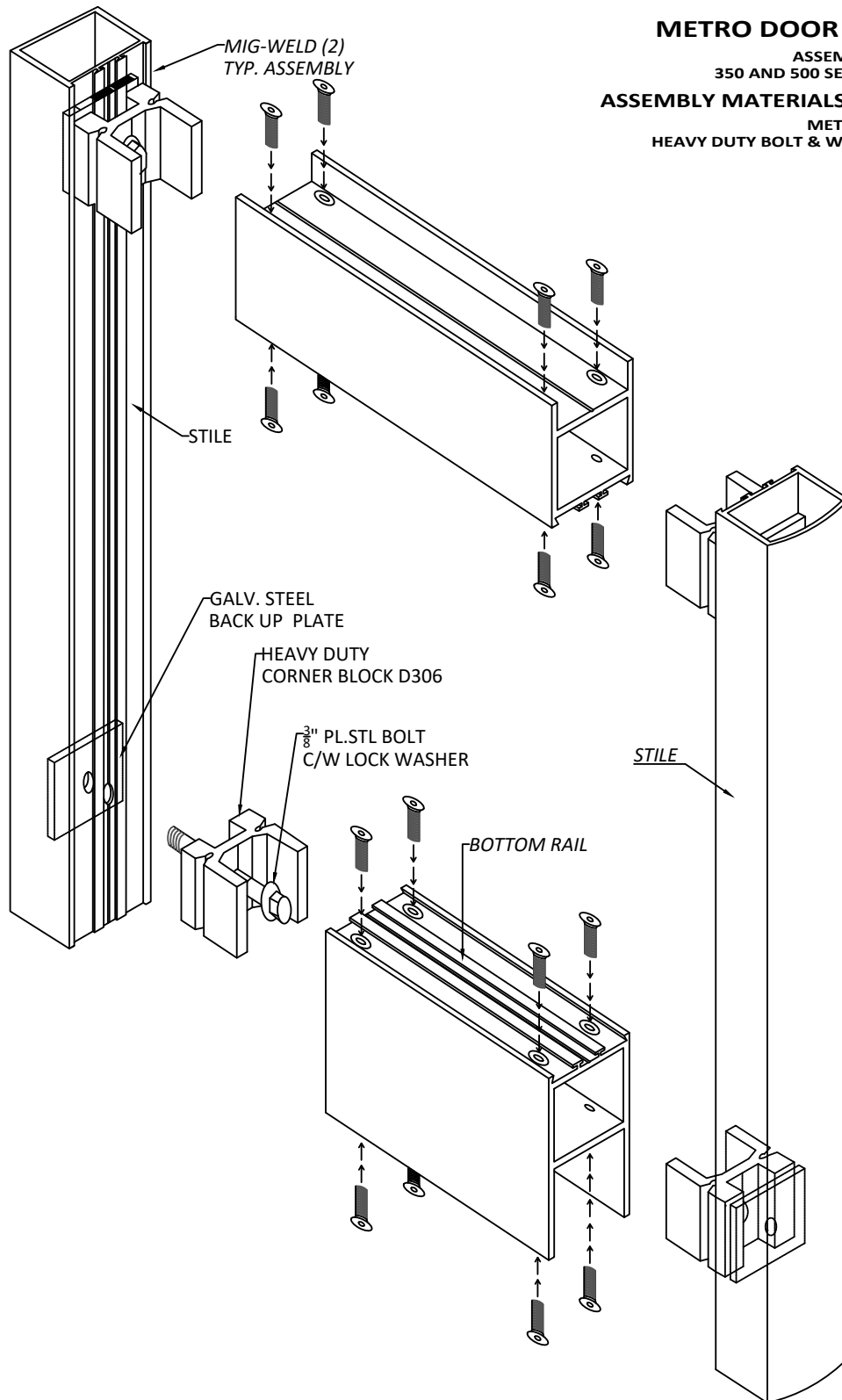

METRO DOOR 250 SERIES
ASSEMBLY DETAILS FOR
350 AND 500 SERIES ARE SIMILAR
ASSEMBLY MATERIALS & METHODS
METRO'S STANDARD -
HEAVY DUTY BOLT & WELD CONNECTION

The 350 Medium Stile Door, designed for high-traffic areas, offers enhanced strength and durability, making it ideal for demanding commercial environments where robust performance and aesthetic appeal are essential.

- **Medium Stile Design:** Provides a sturdy and substantial appearance, suitable for high-use applications.
- **Single and Double Glazed Stops:** Accommodates different glazing configurations for enhanced performance and design flexibility.
- **Heavier Duty Construction:** Ensures long-lasting performance in high-traffic areas.
- **Compatibility with Metro Framing:** Seamlessly integrates with Metro framing systems for a cohesive installation.
- **Mid and Bottom Rails:** Available in various sizes to meet your specific design and functionality requirements. (see page A-08 for details)
- **Welded Corners:** Each corner is welded & bolted for enhanced structural integrity.

Standard hardware includes: (see pages A-11 - A-17)

- Offset Pivots
- Construction Security Lock (Exterior)
- Thumb Turn (Interior)
- Metro Standard Push Bar/Pull Handle
- ½ Inch Threshold
- Exposed Closer

Works with hinging hardware options, including:

- Continuous Hinges
- Butt Hinges
- Center Hung / Walking Beam Pivots

Compatible with most hardware options, including:

- Concealed Closer's
- Apartment Packages (Lever / Paddle)
- Offset D-Pulls and Ladder Pulls

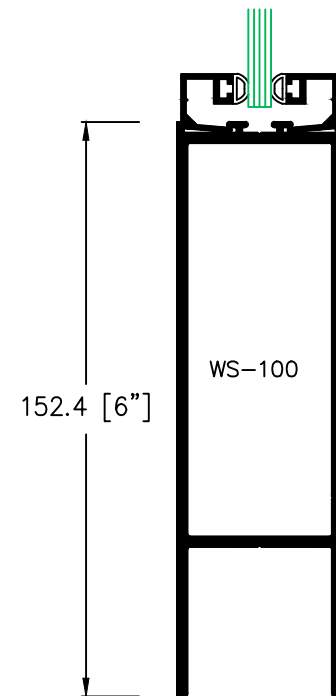
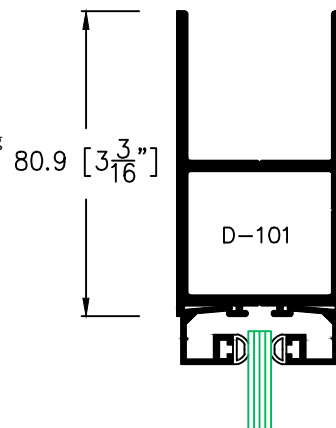
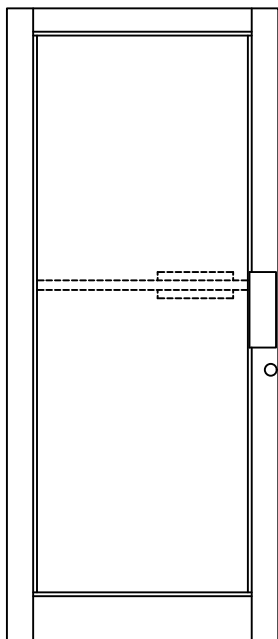

SINGLE GLAZED

DOUBLE GLAZED

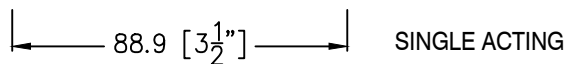
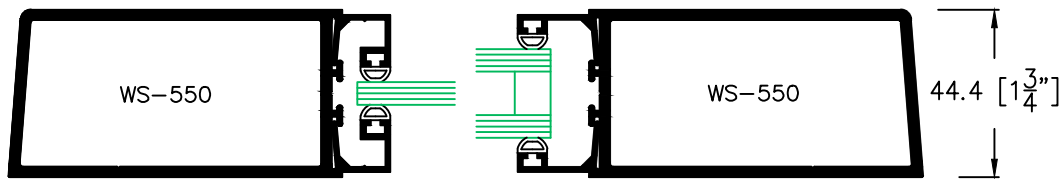

350 SERIES DOOR - 1750 SERIES FRAMING

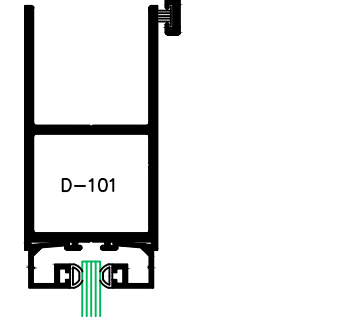
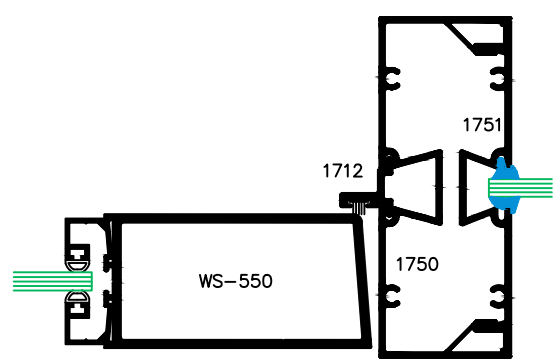
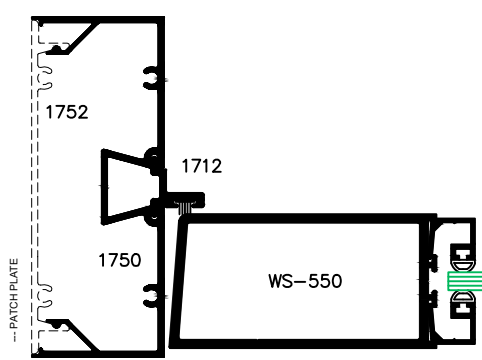
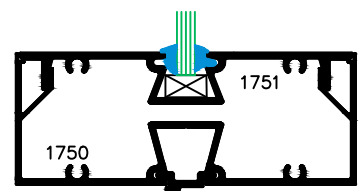
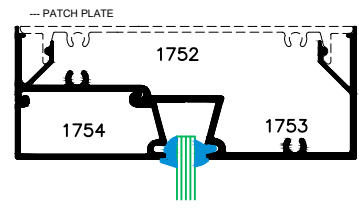
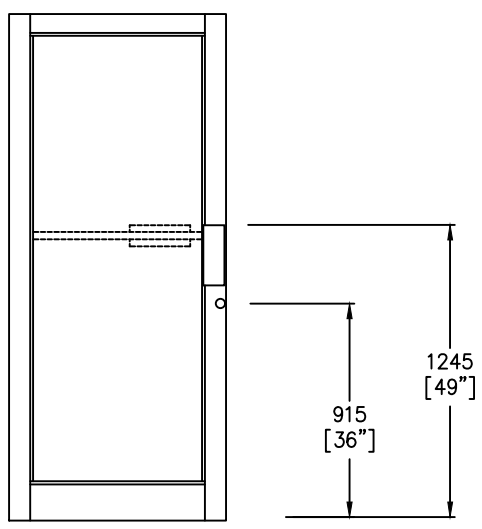

OFFSET HUNG

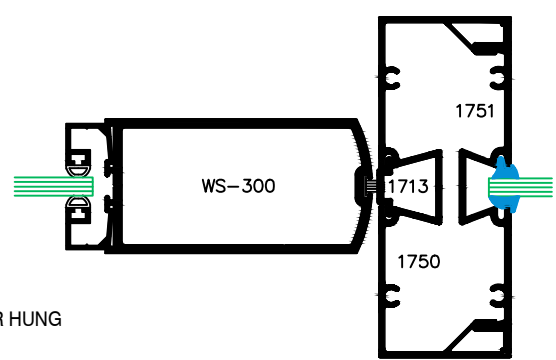
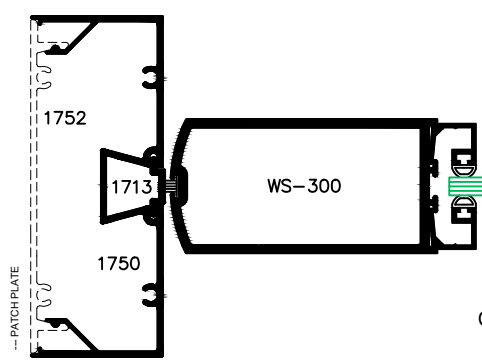

CENTER HUNG

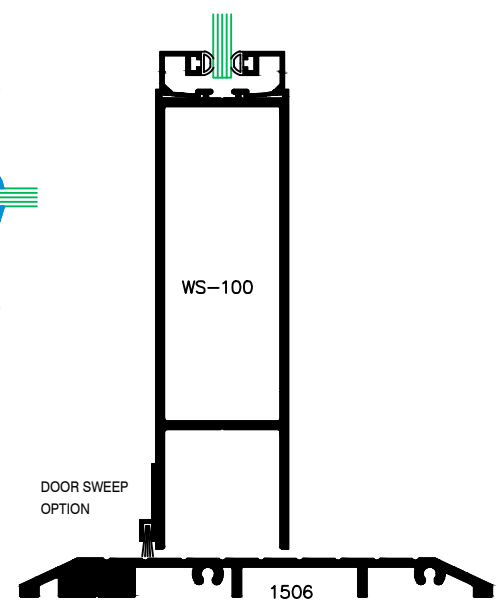

VARIOUS THRESHOLD OPTIONS ARE AVAILABLE

350 SERIES DOOR - 2050 SERIES FRAMING

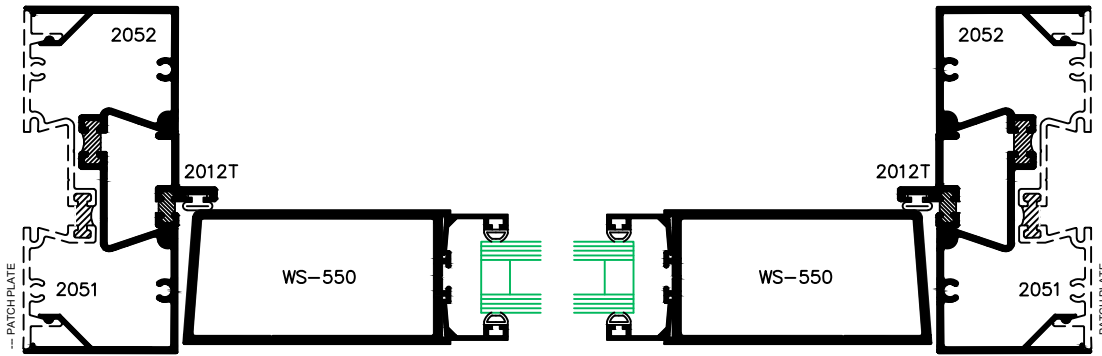
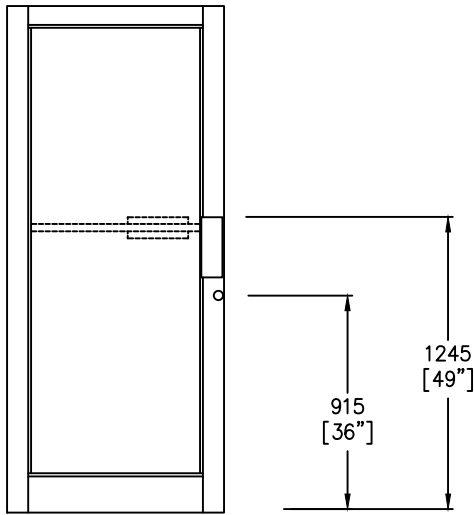

OFFSET HUNG

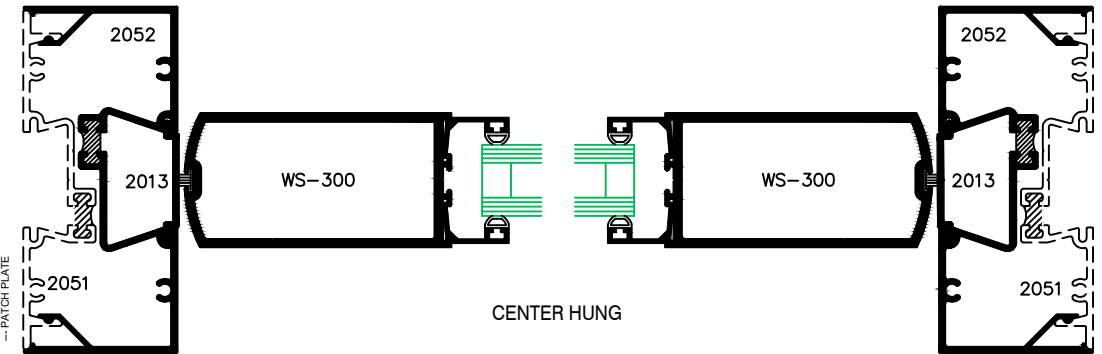

CENTER HUNG

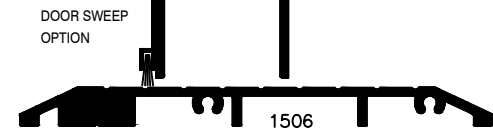
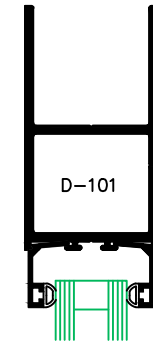
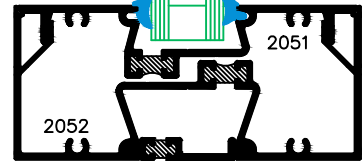
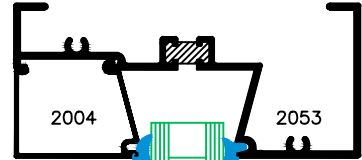

VARIOUS THRESHOLD OPTIONS
ARE AVAILABLE

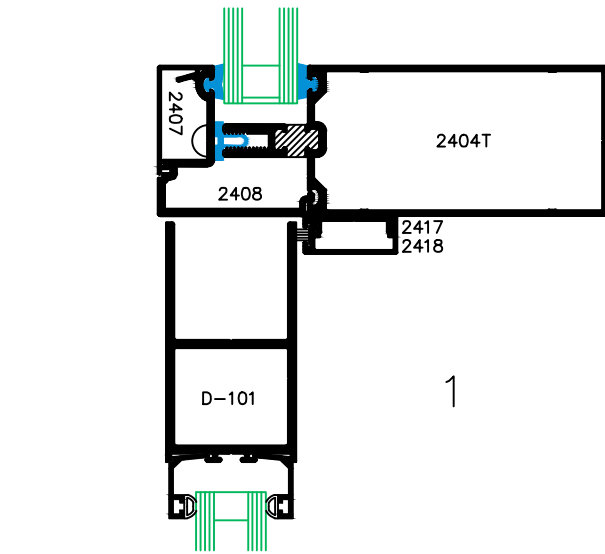

1

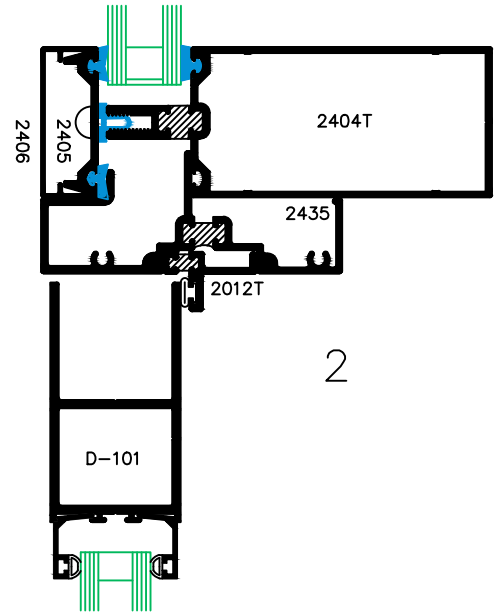

2

DETAILS
2400T FRAMING

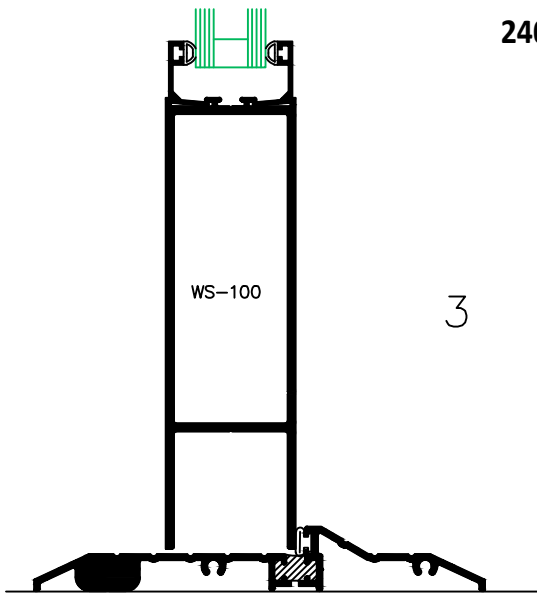

3

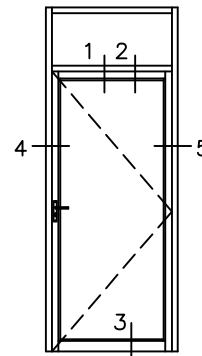

ELEVATION

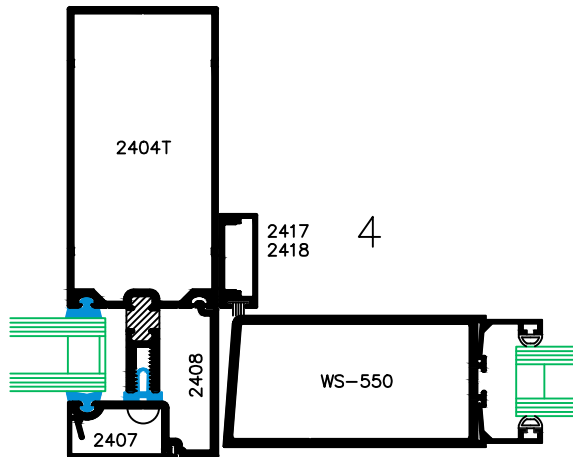

4

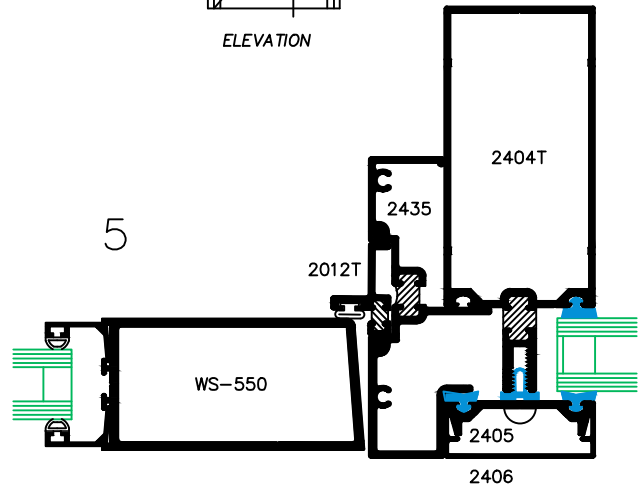

5

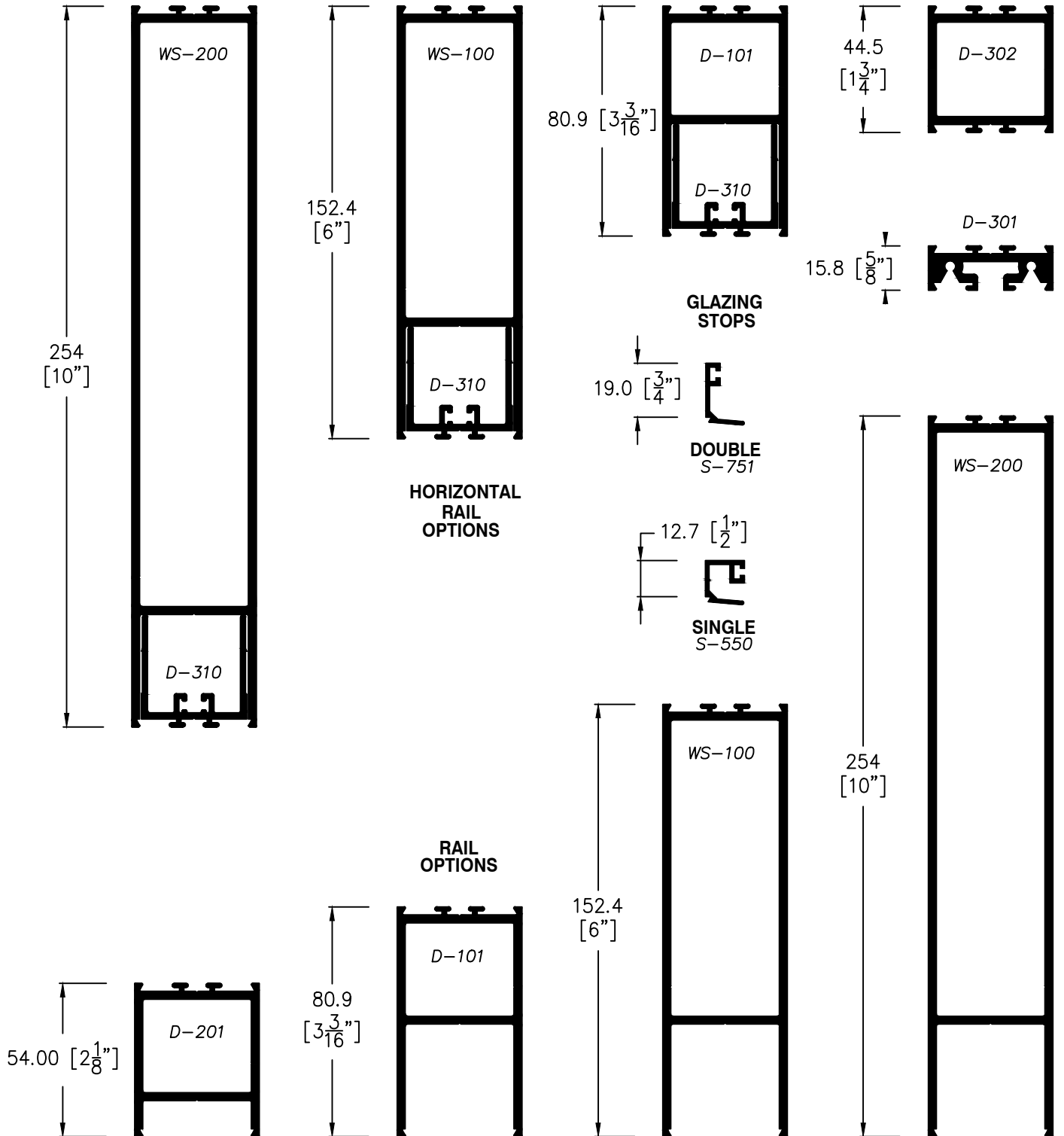

NOTE: CUSTOM RAILS ARE ALSO AVAILABLE



H-100A
M.S DEAD LOCK



H-102A
HOOK LOCK



H-104A
LATCH LOCK



H-104AR
A.R LATCH LOCK



H-114/H-115
KEYED CYLINDER & THUMB TURN

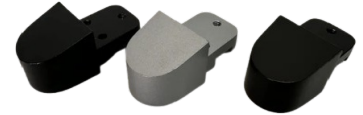

H-118
FRAME PORTION PIVOT

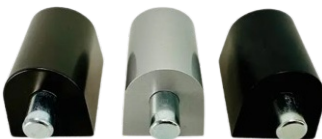

H-119
TOP DOOR PORTION PIVOT

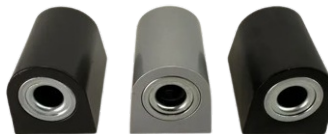

H-120
BOTTOM DOOR PORTION PIVOT



H-121
THRESHOLD PIN



H-121F
FLOOR MOUNTED PIVOT



H-250-1
METRO STANDARD PULL HANDLE



H-250-2
METRO STANDARD PUSH BAR



H-250-5
12" OFFSET D-PULL



H-250-5/H-250-5P
OFFSET D-PULL & TUBULAR PUSH BAR



H-250-6
12" B/B D-PULLS



H-250-5GLP S.S
72" X 1 1/4" OFFSET LADDER PULL



H-250-6GLP S.S
72" X 1 1/4" B/B OFFSET LADDER PULL



H-122
4" X 4 1/2" BUTT HINGE S.S



H-122 BP
4" X 4 1/2" BUTT HINGE BLACK



H-122 PKG
BUTT HINGE WITH BACK UP PLATES



H-122E
4 WIRE BUTT HINGE S.S



H-123A
4 1/2" X 4 1/2" BUTT HINGE S.S



H-124D
BUTT HINGE DOOR BACK UP PLATE



H-124F
BUTT HINGE FRAME BACK UP PLATE



H-130
METRO STANDARD CLOSER



H-130X
STANDARD CLOSER ARM EXTENSION



H-130A DR
STANDARD CLOSER DROP PLATE



H-130 DA
DELAYED ACTION CLOSER



H-128
GLOBAL TC204 CLASS 1 CLOSER



H-1300P
PARALLEL ARM BRACKET



H-4040
GLOBAL 4040 CLOSER



H-4040-18G
GLOBAL 4040 CLOSER DROP PLATE



H-4040-18PA
GLOBAL PARALLEL ARM DROP PLATE



H-4040LA
4040 CLOSER ARM EXTENSION



H-4040XLA
4040 CLOSER XL ARM EXTENSION



H-4040 HOA
4040 CLOSER HOLD OPEN ARM



H-158/H-159/H-160
CONTINUOUS HINGE



H-103AR
A.R DUAL FORCE 2190



H-100EI
EXIT INDICATOR



H-104RL
ROLLER LATCH



1550
S/G LETTER SLOT



1555
INSULATED LETTER SLOT



H-112
LEVER HANDLE

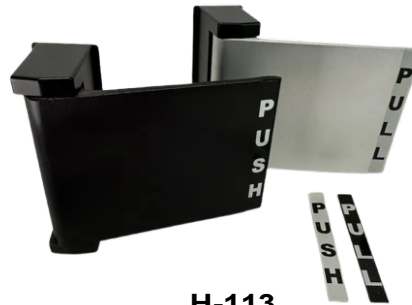

H-113
LATCH PADDLE



H-108P/H-108S
ELECTRIC STRIKES



H-110
RECTIFIER



H-111
ELECTRICAL CONNECTORS



H-104S
G.J HEAVY DUTY DOOR CLOSER



H-107
LATCH LOCK STRIKE



H-107A
LATCH DOUBLE STRIKE



H-106
CYLINDER GUARD



H-114A
GMS R-118 RIM CYLINDER



H-114B
A.R LATCH LOCK



H-114E
2 1/4" SPINDLE EXTENSION KIT



H-116
BLACK CYLINDER



H-117
FLUSH BOLTS



H-126
WALKING BEAM



H-126/H-127
WALKING BEAM PIVOT SET



H-EPT2
A.R POWER TRANSFER



H-137A
ASTRAGAL



H-135
A.R 8400 PANIC



H-135S
8400 PANIC STRIKE



H-135X
8400 PANIC EXTENSION FOR 2" DOORS



H-136
A.R 8600 PANIC



H-136B
8600 PANIC STRIKE



H-136X
8600 PANIC EXTENSION FOR 2" DOORS



H-136
PS-LR POWER SUPPLY



H-136A
CYLINDER MOUNTING PAD



H-148 S.S
G.J SURFACE MOUNTED DOOR STOP



H-131
CONCEALED CLOSER



H-132
CENTER HUNG SIDE LOAD ARM



H-105
COVER PLATES



H-096
HOPPE HANDLE SET - EXTERIOR



H-096
HOPPE HANDLE SET - INTERIOR

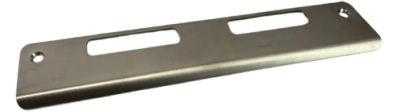

H-096AS
HOPPE LOCK STRIKE



H-096HA
GLOBAL ACTIVE HANDLE SET

STANDARD DOOR SIZES

SINGLE DOOR OPENING	36" x 84"	914 mm x 2134 mm
PAIR OF DOORS OPENING	72" x 84"	1829 mm x 2134 mm

GLASS SIZES FOR SINGLE AND PAIRS OF 250 SERIES DOOR

5 mm SINGLE GLASS	31 7/16" x 77 1/2"	798 mm x 1969 mm
23.8mm GLASS UNIT	31 7/16" x 77 1/2"	798 mm x 1969 mm

GLASS SIZES FOR SINGLE AND PAIRS OF 350 SERIES DOOR

5 mm SINGLE GLASS	28 7/16" x 73 5/8"	722 mm x 1870 mm
23.8mm GLASS UNIT	28 7/16" x 73 5/8"	722 mm x 1870 mm

GLASS SIZES FOR SINGLE AND PAIRS OF 500 SERIES DOOR

5 mm SINGLE GLASS	25 7/16" x 70 13/16"	646 mm x 1798 mm
23.8mm GLASS UNIT	25 7/16" x 70 13/16"	646 mm x 1798 mm

PAIR OF DOORS VIEWED FROM OUTSIDE

INACTIVE LEFT LEAF	i.e. FLUSH BOLTS
INACTIVE RIGHT LEAF	i.e. LOCK and CYLINDER

AVAILABLE GLASS STOPS

5 mm GLASS	SQUARE STOP 1/2" FACE WIDTH
SINGLE GLAZED DOOR	
23.8mm GLASS UNIT	
DOUBLE GLAZED DOOR	SQUARE STOP 3/4" FACE WIDTH

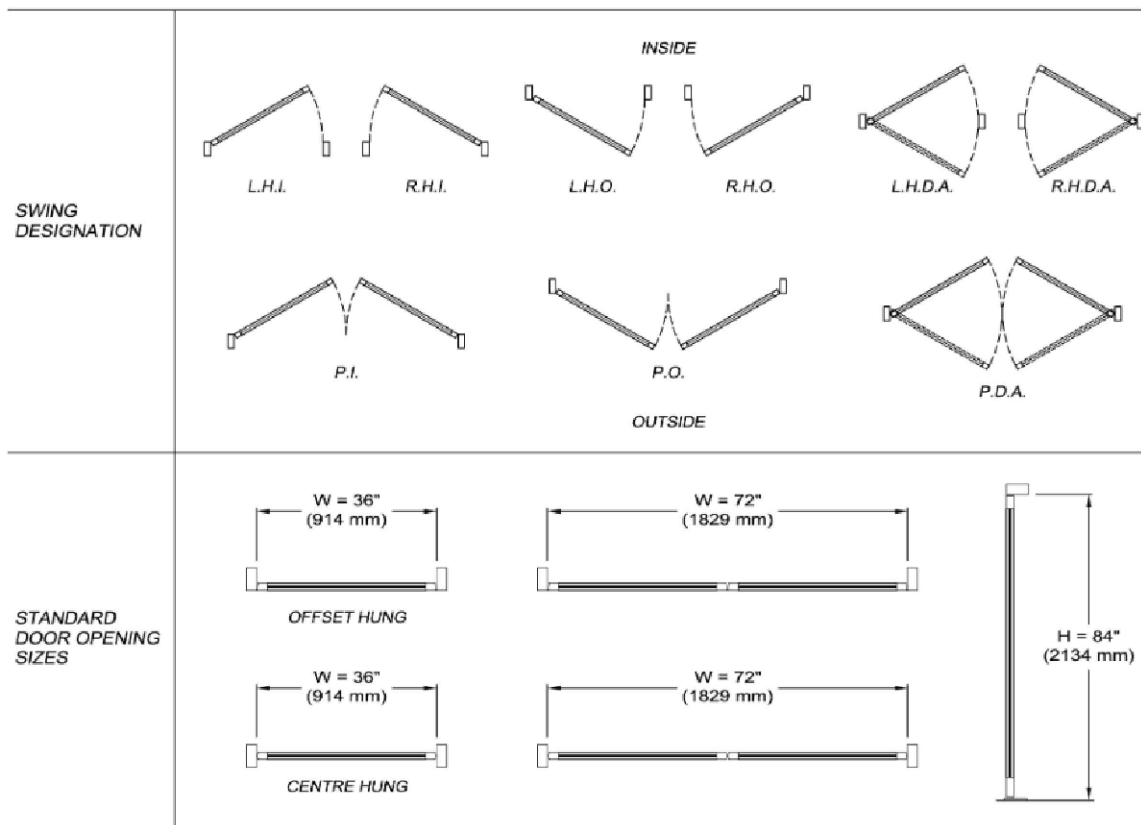

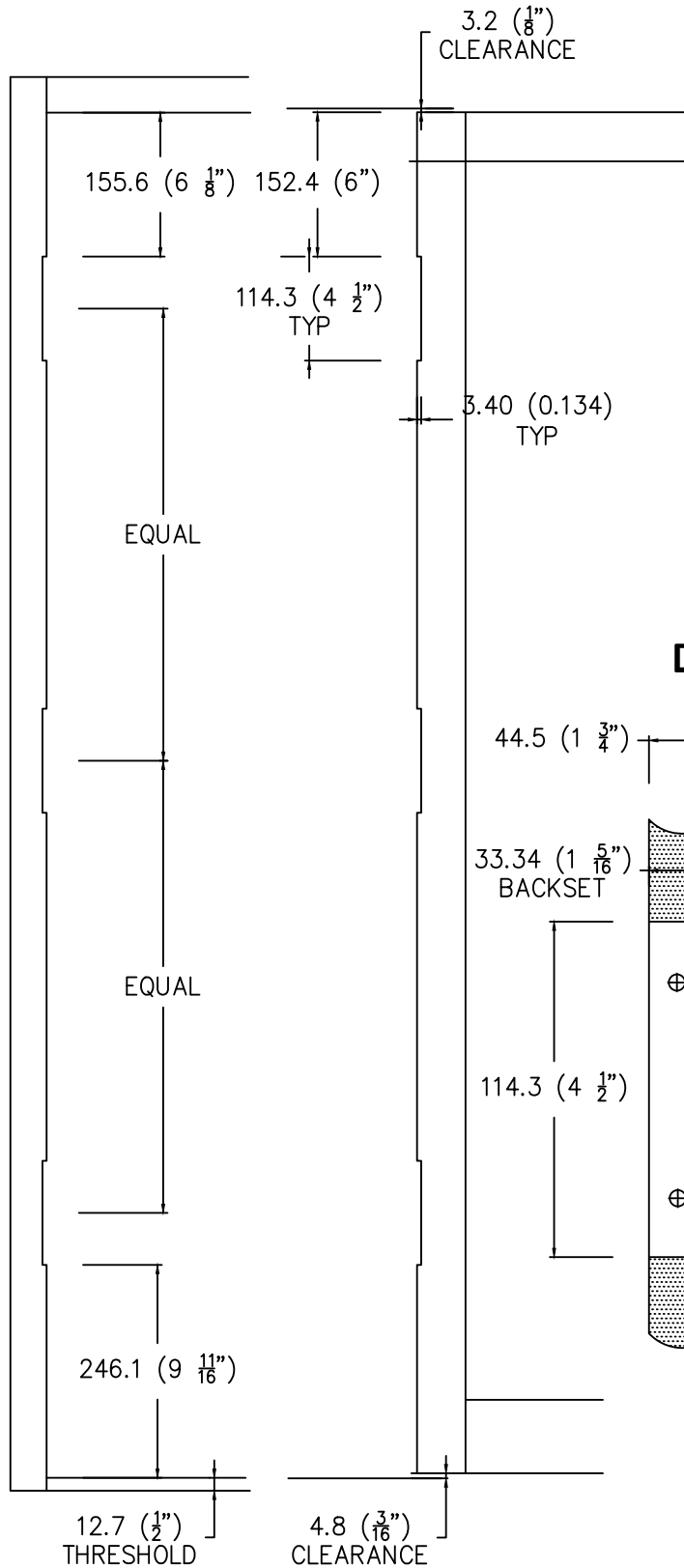

STANDARD BUTT LOCATIONS

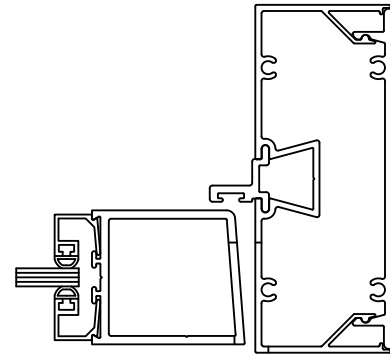

3.40 (0.134) ±

DOOR

FRAME

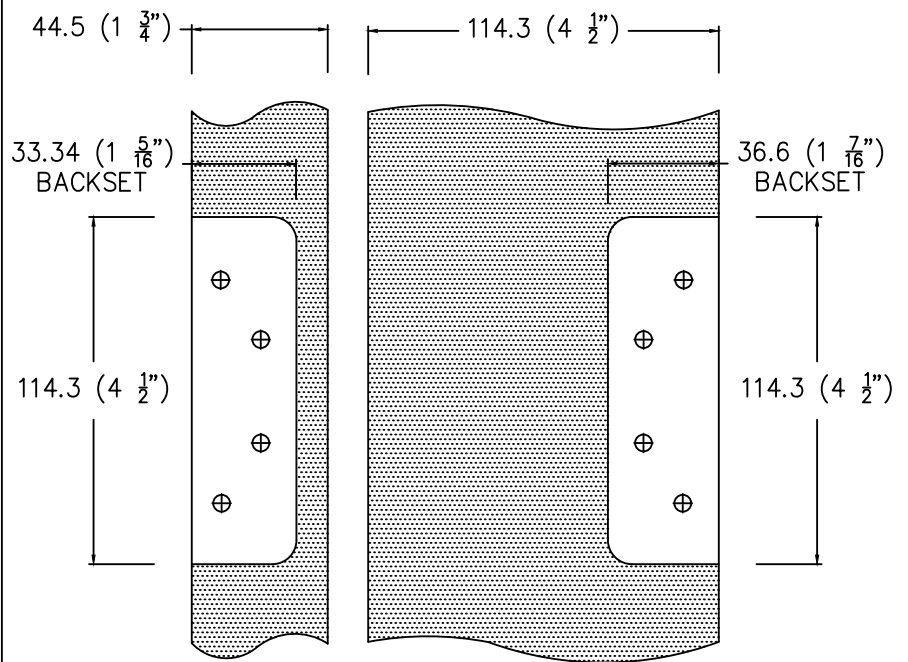

FRAME

DOOR

INSTALLATION DETAILS

