



**METRO  
ALUMINUM**

*Products Ltd.*

# 450T SERIES

T/B FIXED WINDOW SYSTEM WITH  
TOPHAT EXTENSION 4 1/2" (114.3 mm)

**E**



## Part 1 - GENERAL

Scope - The fixed window framing system shall be \_\_\_\_\_ Series as manufactured by METRO ALUMINUM Products Ltd. Supply and install aluminum framing, as described on the architectural drawings and as specified herein.

Work Not Included - See: Specifier's lists of excluded items; Items furnished but not installed and/or Items installed but not furnished.

Related Work Specified Elsewhere - See: Specifier's lists and related Sections.

Design & Performance Requirements - Framing shall fully comply with applicable standard specifications as typically referenced to the following performance requirements criteria: Air Tightness, Water Tightness, Wind (and other applicable) Load Resistance, Temperature Index and Energy Performance – an others as described in CAN/CSA-A440-M90 - Windows - (Specifier's selection)

Submittals - Shop Drawings & Samples - Submit all documentation and samples for review by Consultant at one time, prior to fabrication of curtain wall products.

Quality Assurance - Provide all necessary information to show that all involved products meet or exceed the requirements of these specifications.

Delivery, Storage and Handling - Deliver, store, handle, protect and schedule materials and products so as to avoid any damage. Follow recommendations of AAMA CW-10 "Care and Handling of Architectural Aluminum from Shop to Site" and others as applicable.

## Part 2 - PRODUCTS

Materials - All materials to meet the applicable minimum design and specifications requirements. Any defects impairing strength, durability or appearance are not acceptable. Extruded aluminum shall be AA 6063 T6 alloy and temper -  $F_y = 110 \text{ MPa}$  (16 KSI) minimum. Sufficient strength and size assembly and anchoring shall be made of corrosion-resistant and compatible material such as cadmium or zinc plated carbon steel or stainless steel. Separate incompatible materials and prevent galvanic action (electrolytic corrosion). Structurally adequate anchoring metal brackets shall be anticorrosive painted. Conventional wet-dry, inside glazing method shall be applicable. Gasketing to utilize: standard exterior glazing butyl tape completed with hard extruded shim and interior dense gasket extruded from Neoprene, EPDM or other equal material, as required. Gasket profile shall be designed and sized to uniformly fit tight and properly seal glass-metal interfacing. Acceptable gasket compression range to be 0.7 to 1.7 kN/m (4 – 10 lbs/in). Glass setting to be compatible with glass unit seals and/or other parts involved as required.

System Description - Framing System shall be 250, 350, 350T, 425T, 450, 450T, 460T - non-thermally broken/uninsulated (thermally broken/insulated - T), for single glass (sealed insulating glass units) METRO Series - Specifier selection - as manufactured by METRO ALUMINUM Products Ltd. Reference dimensions of extruded profiles shall be (Specifier's selection):  
250 – 2.5" (63.5 mm) – Single & Double Stop – NTB  
350 – 3.5" (88.9 mm) – Single & Double Stop – NTB  
350T – 3.5" (88.9 mm) – Double Stop – TB  
425T Tophat – 4.25" (107.9 mm) – Double Stop – TB  
450 Tophat – 4.5" (114.3 mm) – Double Stop – NTB

450T Tophat – 4.5" (114.3 mm) – Double Stop – TB  
460T Tophat – 6.25" (158.8 mm) – Double Stop – TB.  
Where applicable, thermal break shall be polyurethane poured-in resin type.

Glass perimeter retention, as for wet-dry glazing method, shall be achieved by exterior glazing tape and interior glazing stop profile c/w inorganic rubber gasket. Glass hard bite to be 12.7 mm (0.5") minimum.

Whenever substitute/alternative products are considered, supporting data to be submitted ten (10) days prior to bid date to allow for valid comparison. Approval of alternates to be confirmed in advance of bid closing by addendum only.

Fabrication - Extruded profiles shall be accurately fabricated and assembled and sealed to provide air/water tight fit hairline joints only. Fastening shall allow for permanent true and square set of frame elements. Assembly shall utilize concealed screws only. Properly sealed frame assembly interfacing joints shall result in uninterrupted continuity of air barrier and compartmentization. Reference glazing system type to be one of the following (Specifier's selection):

Prime Seal – Exterior glazing shimmed tape and interior extruded rubber gasket,

Vented Cavity – As the above, plus heel bead with 4" returns at inner light, and weep holes as required,

Rain-Screen – As the above, plus heel bead at full perimeter at inner light, and weep holes as required.

Sill and head flashing shall be designed and fabricated to suit site conditions as required. Frame assemblies shall be free of warp. No exposed fasteners are permitted.

Finish - All exposed surfaces shall be finished as specified. The finish, as per AAM designation, shall be (Specifier's selection):

Standard clear anodizing to AA - M12C22A31

Standard perma bronze to AA - M12C22A44

Standard black anodizing to AA - M10C21A44

Duracron acrylic enamel to AA - M12C4XR1X

Custom paint qualities and colors - Specifier's selection.

## Part 3 - EXECUTION

Installation – Anchoring shall suit perimeter conditions of rough openings and seals as required. Prefabricated/preglazed framing to be installed at prepared openings, at correct locations as shown on drawings, set level, plumb, square and aligned with other work in accordance with manufacturer's instructions, approved shop and erection drawings. Perimeter joints to be sealed/caulked as specified and detailed to ensure weathertight assembly.

Protection and Cleaning - Work to be protected from damage during and after installation. Consult with manufacturer and installer to determine appropriate protective measures. The General Contractor shall be responsible for protection during construction and for final cleaning. After installation, aluminum work and glass to be cleaned according to instructions/manuals provided by product manufacturers and glaziers. Use appropriate cleaning materials and methods. Do not scratch or damage glass or finishes.



**COMPONENTS**

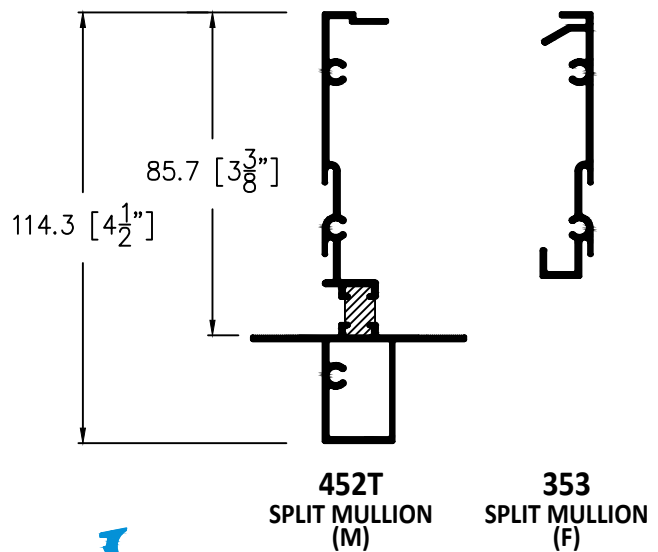
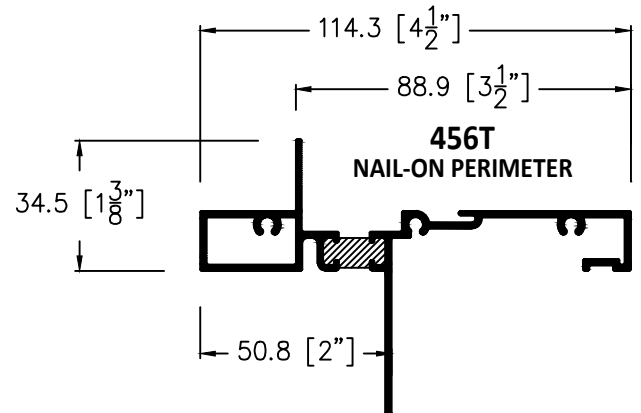
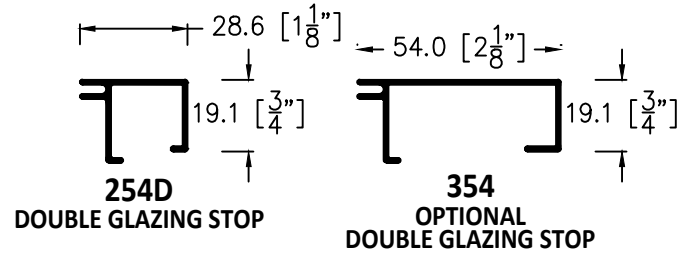
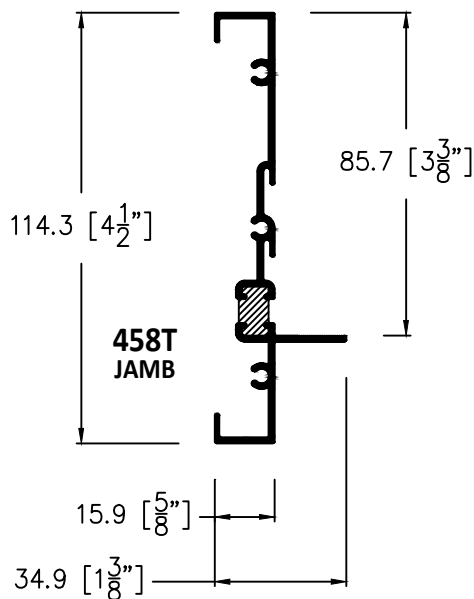
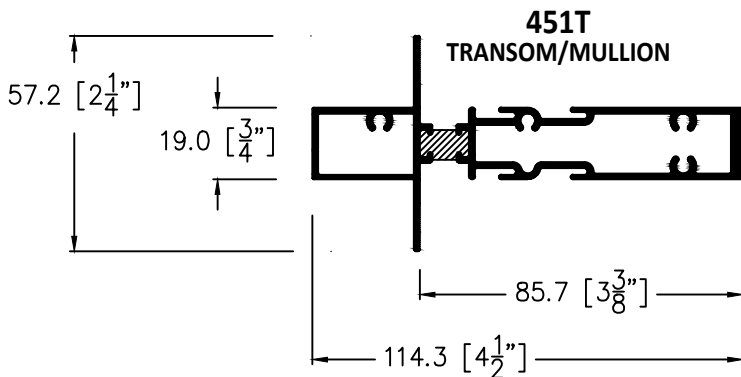
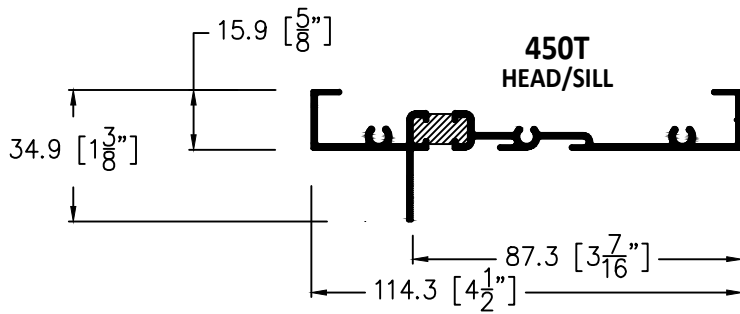
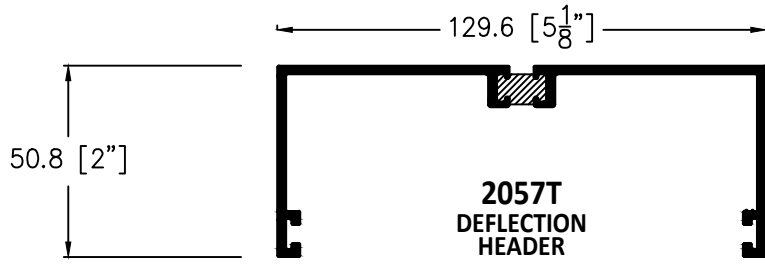

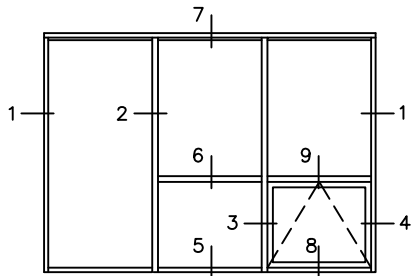

ELEVATION

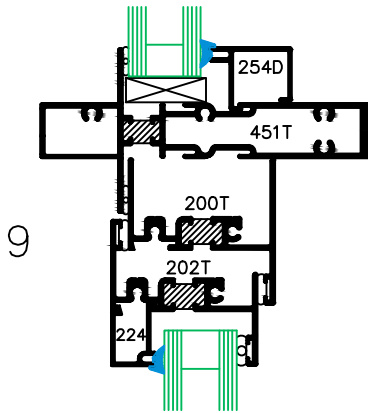

OPEN-OUT  
VENT  
200T SERIES

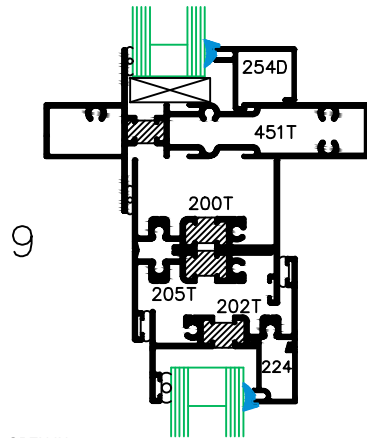

OPEN-IN  
VENT  
200T SERIES

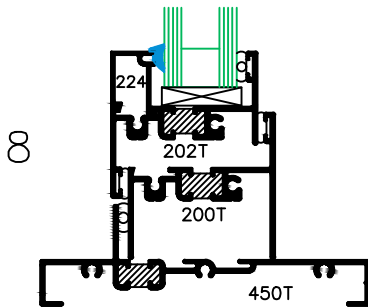

8

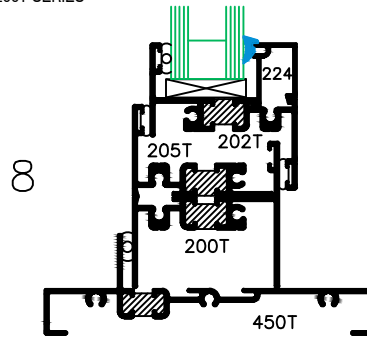

8

DETAILS

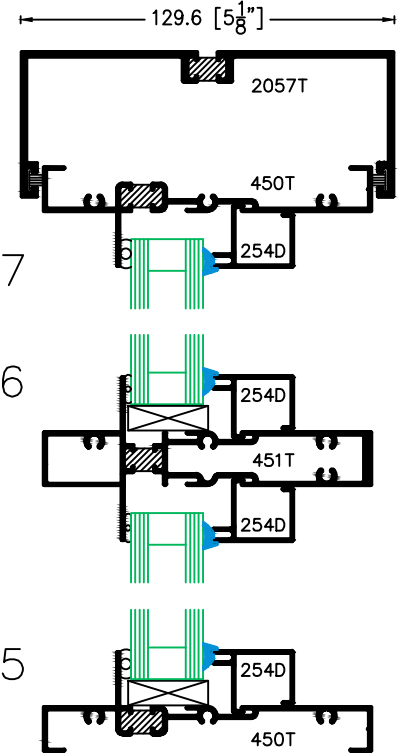

7

6

5

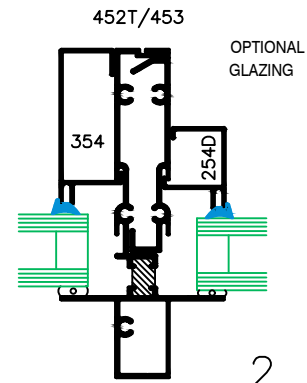

OPTIONAL  
GLAZING

2

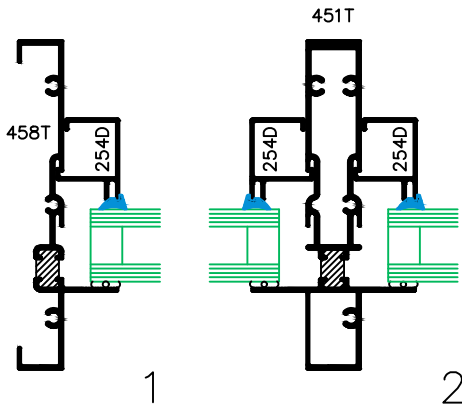

1

2

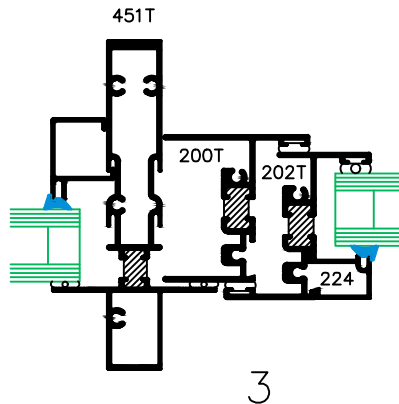

3

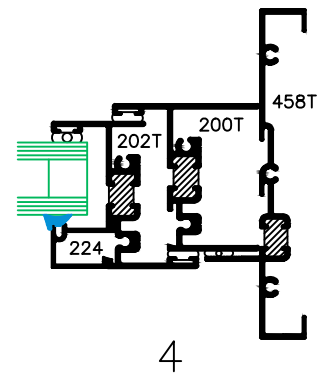

4