



## Part 1 - GENERAL

Scope - The doors shall be \_\_\_\_\_ as manufactured by METRO ALUMINUM Products Ltd. Supply and install aluminum doors, as described on the architectural drawings and as specified herein.

Work Not Included - See: Specifier's lists of excluded items; Items furnished but not installed and/or Items installed but not furnished.

Related Work Specified Elsewhere - See: Specifier's lists and related Sections.

Design & Performance Requirements - Doors to fully comply with applicable standard specifications as typically referenced to the following performance requirements criteria: Air Tightness, Water Tightness, Wind and Other Load resistance, Temperature Index and Energy Performance. (Specifier's selection)

Submittals - Shop Drawings & Samples - Submit all documentation and samples for review by Consultant at one time, prior to fabrication of door products.

Quality Assurance - Provide all necessary information to show that all involved products meet or exceed the requirements of these specifications.

Delivery, Storage and Handling - Deliver, store, handle, protect and schedule materials and products so as to avoid any damage. Follow recommendations of AAMA CW-10 "Care and Handling of Architectural Aluminum from Shop to Site" and others as applicable.

## Part 2 - PRODUCTS

Materials - All materials to meet the minimum design and materials specifications as applicable. Any defects impairing strength, durability or appearance are not acceptable. Extruded aluminum shall be AA 6063 T6 alloy and temper - Fy = 110 MPa (16 KSI) minimum.

Sufficient strength and size fasteners shall be made of corrosion-resistant and compatible material such as cadmium or zinc plated carbon steel, stainless steel or aluminum, to prevent any galvanic action (electrolytic corrosion). Standard weathering at perimeter frame shall be pile cloth with a vinyl fin - minimum, or an extruded thermoplastic elastomer tubular profile with a semirigid setting key (Specifier's selection). Optional weathering at the bottom rail shall be a sweep blade type strip secured with concealed fasteners. Dry glazing method to utilize extruded dense Neoprene, EPDM, or other equal material; spline (and/or wedge) gaskets set into extruded aluminum stops. Gasket profile shall be designed and sized to fit tight and properly seal glass-metal interfacing. Glass setting to be compatible with glass unit seals and/or other parts involved as required.

System Description - Door System shall be type out-swing/in-swing \_\_\_\_\_. METRO Series for single glass (for sealed insulating glass units), uninsulated (insulated) - Specifier selection - as manufactured by METRO ALUMINUM Products Ltd.

Reference minimum thickness of extruded metal shall be: Frame 3 mm (0.12") and Glazing Stop 1.3 mm (0.05") minimum.

Frame nominal dimensions of extruded metal shall be:

|                       |       |
|-----------------------|-------|
| Depth of frame        | _____ |
| Width of stile        | _____ |
| Height of top rail    | _____ |
| Height of middle rail | _____ |
| Height of bottom rail | _____ |

Glass retention, as for dry glazing method, shall be achieved by extruded aluminum glazing stop profile and inorganic rubber gasket. Whenever substitute/alternative products are considered, supporting data to be submitted ten (10) days prior to bid date to allow for valid comparison. Approval of alternates to be confirmed in advance of bid closing by addendum only.

Fabrication - Tubular profiles of rails and stiles shall be accurately fabricated and assembled to provide tight fit hairline joints only. Corner joinery shall utilize assembly spigot-bracket. Parts involved shall be fastened by means of anticorrosive steel screws and bolts with additional securing welds to allow for permanent true and square set of frame elements. Extruded aluminum square glazing stops, equipped with hollow gaskets, shall secure glass on both sides. Specified hardware shall be connected accurately to aluminum framing as per manufacturer's specifications. No exposed fasteners are permitted. Each door leaf to be equipped with adjusting mechanism, set at the top rail, to allow for necessary installation adjustments. Both stiles of centre hung single door, hinge and meeting stile (1) sides of centre hung pair doors shall be furnished with hard-backed poly pile weather-stripping, as required. Perimeter frame of offset pivoted (or butt hung) doors to have weather-strip stops at jamb and head. Active meeting stiles of pairs to be furnished with matching weather-strip device set and secured in appropriate reveal-groove. Bottom rail to receive weather-strip sweep as required.

Finish - All exposed surfaces shall be finished as specified. The finish, as per AAM designation, shall be (Specifier's selection):

Standard clear anodizing to AA - M12C22A31  
Standard perma bronze to AA - M12C22A44  
Standard black anodizing to AA - M10C21A44  
Duracron acrylic enamel to AA - M12C4XR1X  
Custom paint qualities and colors - Specifier's selection.  
Hardware to have manufacturer's standard finish.

Hardware - Hardware shall be supplied by METRO ALUMINUM Products Ltd. for factory installation, and to include: (Specifier's selection):

Top and bottom offset pivots.  
Intermediate offset pivots where required, or  
1 pair or 1.5 pairs of 100 mm x115 mm (4" x 4.5") butt hinges, or  
Centre hung pivots compatible with centre hung closers.  
Push-pull - Metro standard.  
Door closers - streamline or concealed.  
Standard 150 mm (6") threshold with reinforced pivot anchor point.  
Panic device. Various types available - Specifier's selection.  
Alternative hardware clause: Hardware as specified under separate section of the Specifications. The manufacturer shall furnish all necessary templates for assembly and installation.

## Part 3 - EXECUTION

Installation - Doors to be installed in prepared openings, at correct locations as shown on drawings, set level, plumb, square and aligned with other work in accordance with manufacturer's instructions, approved shop and erection drawings. Operating hardware, checked and adjusted as required, shall be left in ready for use condition. Perimeter joints to be sealed/caulked as specified and detailed to ensure weathertight assembly.

Protection and Cleaning - Work to be protected from damage during and after installation. Consult with manufacturer and installer to determine appropriate protective measures. The General Contractor shall be responsible for protection during construction and for final cleaning. After installation, aluminum work and glass to be cleaned according to instructions/manuals provided by product manufacturers and glaziers. Use appropriate cleaning materials and methods. Do not scratch or damage glass or finishes.

Note: The above Specifications should relate to The Product Specifications by METRO ALUMINUM Products Ltd. as applicable to the specific door types such as: 250, 350 and 500 Series.

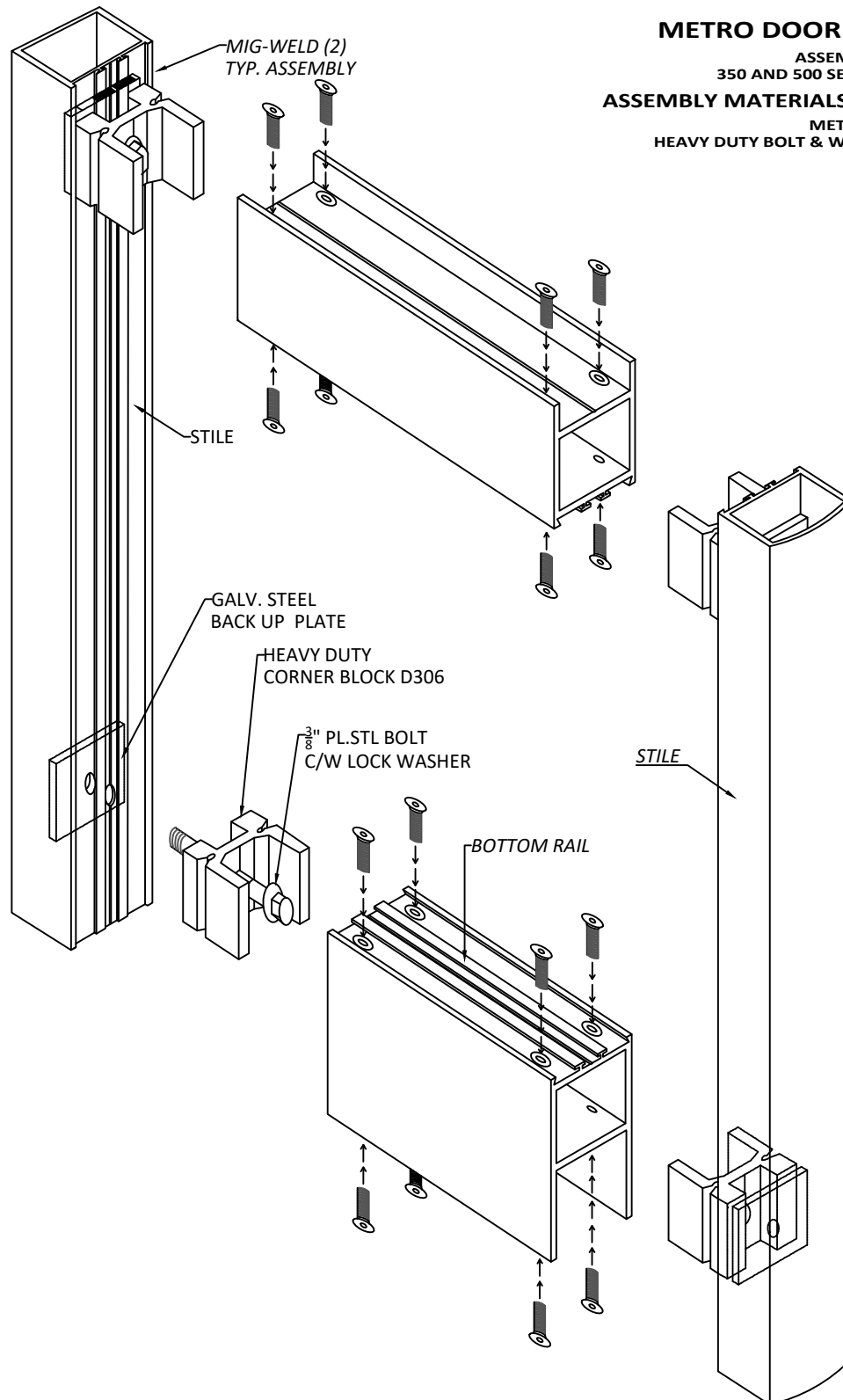

**METRO DOOR 250 SERIES**  
ASSEMBLY DETAILS FOR  
350 AND 500 SERIES ARE SIMILAR  
**ASSEMBLY MATERIALS & METHODS**  
METRO'S STANDARD -  
HEAVY DUTY BOLT & WELD CONNECTION

The 500T Series Thermally Broken Wide Stile Door combines a monumental appearance with superior thermal performance and durability, ideal for prestigious commercial and institutional settings. Key features include:

- **Thermally Broken/Insulated Rails and Stiles:** Ensures optimal thermal insulation, reducing energy loss and enhancing comfort.
- **Sealed Unit Glazing:** Providing enhanced weather resistance and improved insulation.
- **Heavier Duty Construction:** Built for durability and longevity, ensuring reliable performance and high-traffic areas.
- **Compatibility with Metro Thermally Broken Framing:** Seamlessly integrates with Metro framing systems for a cohesive installation.
- **Mid and Bottom Rails:** Available in various sizes to meet your specific design and functionality requirements. (see page A-08a for details)
- **Welded Corners:** Each corner is welded & bolted for enhanced structural integrity.

**Standard hardware includes:** (see pages A-13 - A-13F)

- Offset Pivots
- Construction Security Lock (Exterior)
- Thumb Turn (Interior)
- Metro Standard Push Bar/Pull Handle
- ½ Inch Threshold
- Exposed Closer

**Works with hinging hardware options, including:**

- Continuous Hinges
- Butt Hinges
- Center Hung / Walking Beam Pivots

**Compatible with most hardware options, including:**

- Concealed Closer's
- Apartment Packages ( Lever / Paddle)
- Offset D-Pulls and Ladder Pulls

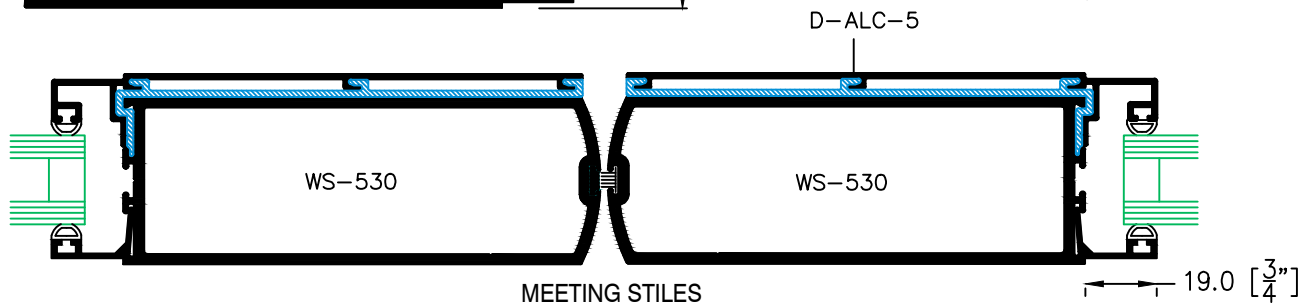
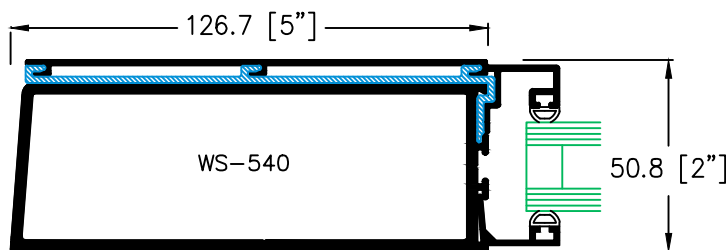
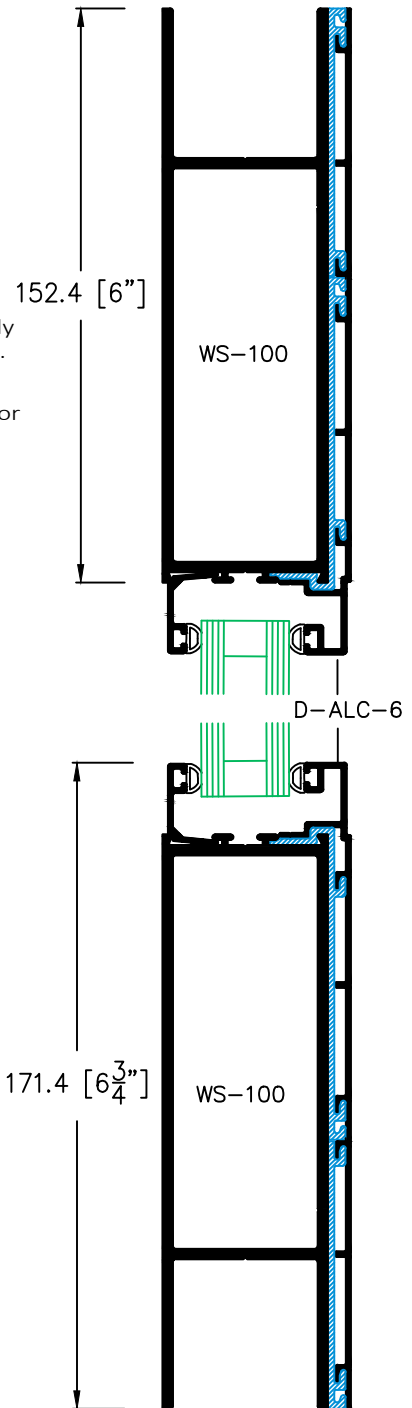
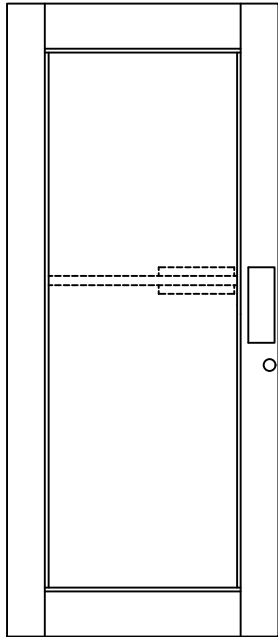

## 500T SERIES DOOR - 2050 SERIES FRAMING

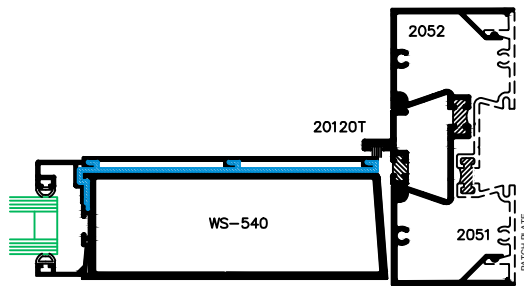
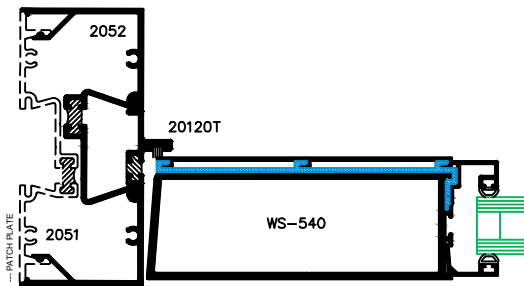
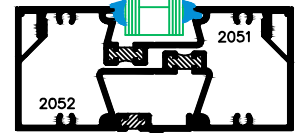
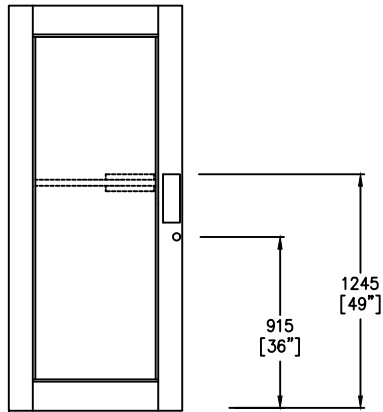

OFFSET HUNG

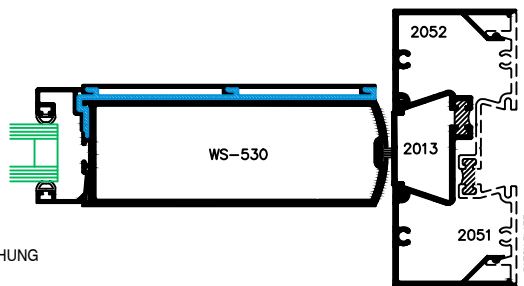
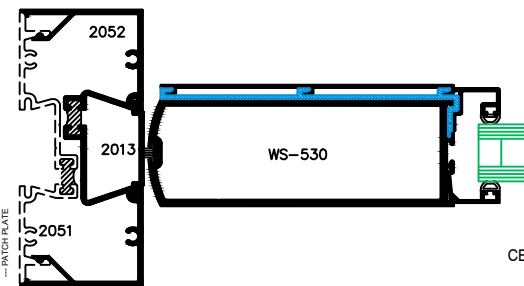

CENTER HUNG

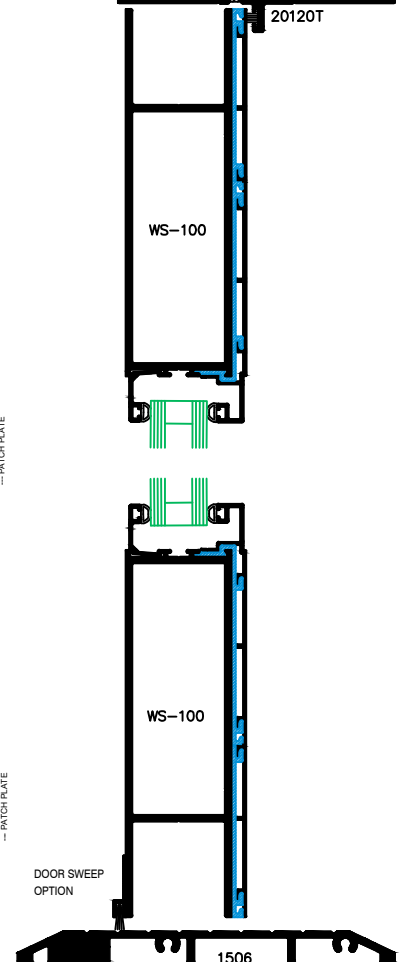

DOOR SWEEP  
OPTION

VARIOUS THRESHOLD OPTIONS  
ARE AVAILABLE

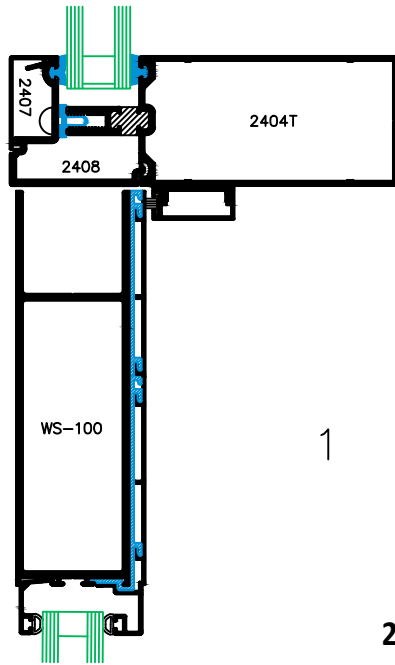

1

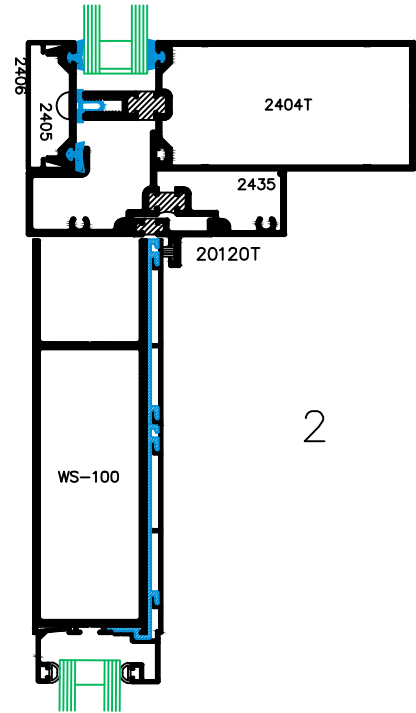

2

DETAILS  
2400T FRAMING

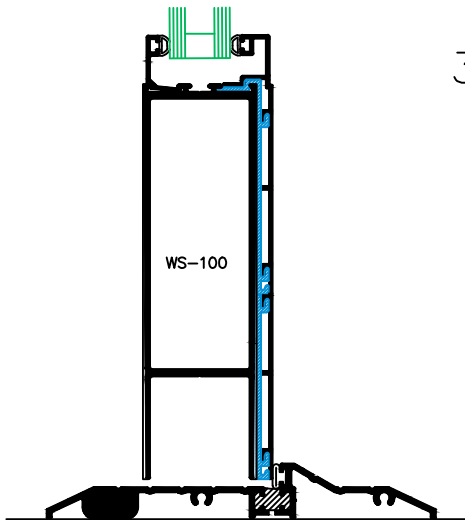

3

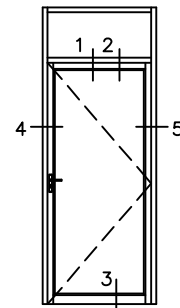

ELEVATION

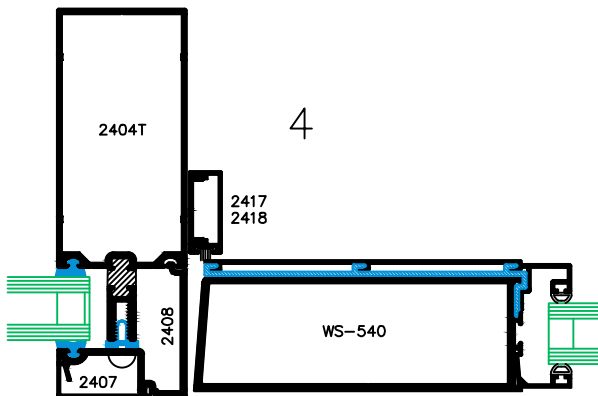

4

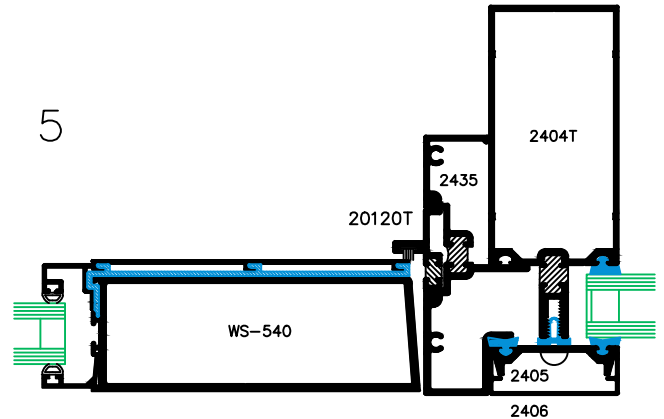

5



**METRO  
ALUMINUM**  
*Products Ltd.*

# DOOR PARTS

THERMALLY BROKEN  
2" CLADED DOOR

**A  
09A**

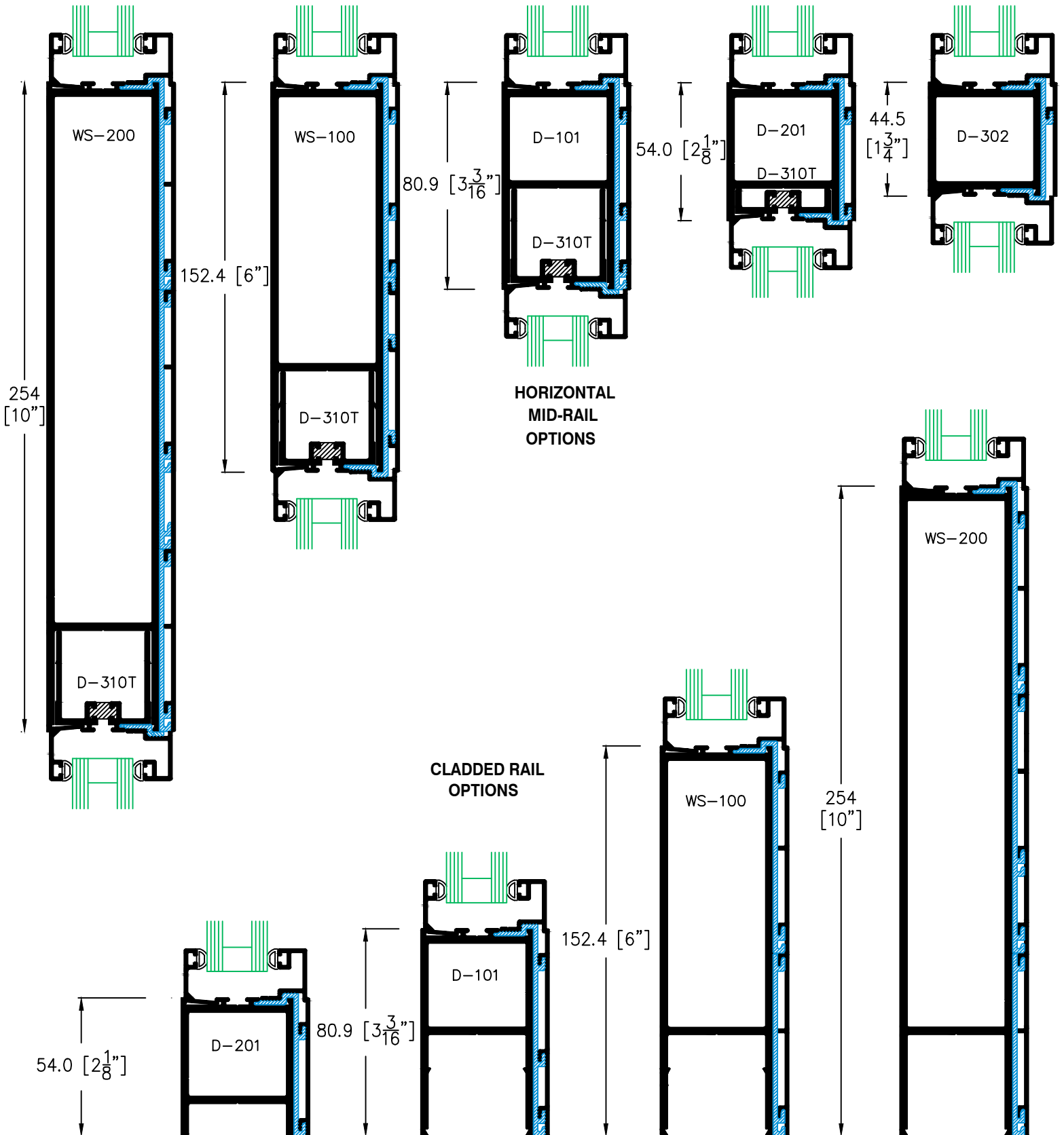

6" THRESHOLDS FOR  
4 1/2" SYSTEM

1506



1506T



2106 BEVELLED



2106T SQUARE



2107T SQUARE

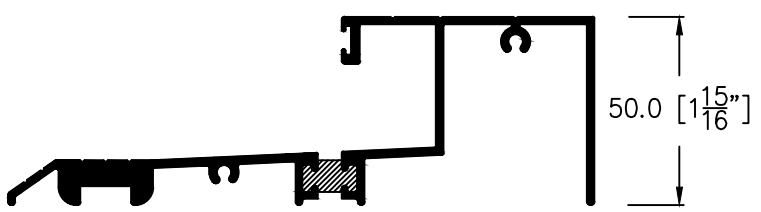

5" THRESHOLDS FOR  
3 1/4" SYSTEM

1306



1306T



2306 BEVELLED

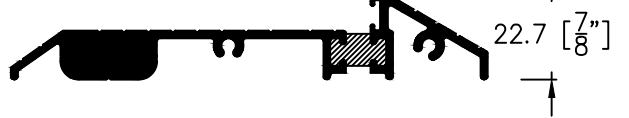

2306T SQUARE



G-2306ST SQUARE

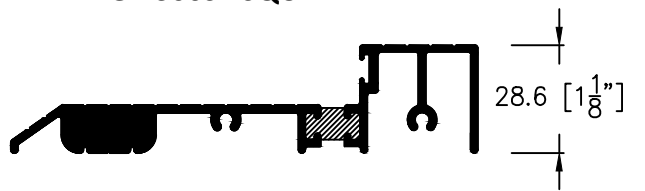

1507

7" THRESHOLDS

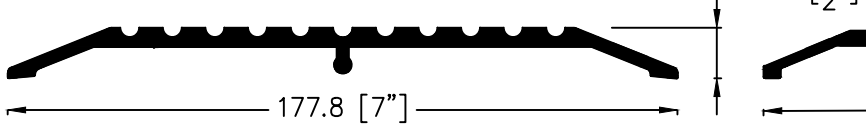

1508

8" THRESHOLDS

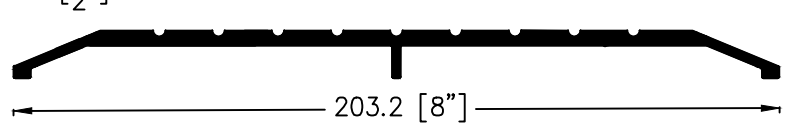

### STANDARD DOOR SIZES

|                       |           |                   |
|-----------------------|-----------|-------------------|
| SINGLE DOOR OPENING   | 36" x 84" | 914 mm x 2134 mm  |
| PAIR OF DOORS OPENING | 72" x 84" | 1829 mm x 2134 mm |

### GLASS SIZES FOR SINGLE AND PAIRS OF 250 SERIES DOOR

|                   |                    |                  |
|-------------------|--------------------|------------------|
| 5 mm SINGLE GLASS | 31 7/16" x 77 1/2" | 798 mm x 1969 mm |
| 23.8mm GLASS UNIT | 31 7/16" x 77 1/2" | 798 mm x 1969 mm |

### GLASS SIZES FOR SINGLE AND PAIRS OF 350 SERIES DOOR

|                   |                    |                  |
|-------------------|--------------------|------------------|
| 5 mm SINGLE GLASS | 28 7/16" x 73 5/8" | 722 mm x 1870 mm |
| 23.8mm GLASS UNIT | 28 7/16" x 73 5/8" | 722 mm x 1870 mm |

### GLASS SIZES FOR SINGLE AND PAIRS OF 500 SERIES DOOR

|                   |                      |                  |
|-------------------|----------------------|------------------|
| 5 mm SINGLE GLASS | 25 7/16" x 70 13/16" | 646 mm x 1798 mm |
| 23.8mm GLASS UNIT | 25 7/16" x 70 13/16" | 646 mm x 1798 mm |

### PAIR OF DOORS VIEWED FROM OUTSIDE

|                     |                        |
|---------------------|------------------------|
| INACTIVE LEFT LEAF  | i.e. FLUSH BOLTS       |
| INACTIVE RIGHT LEAF | i.e. LOCK and CYLINDER |

### AVAILABLE GLASS STOPS

|                           |                             |
|---------------------------|-----------------------------|
| 5 mm GLASS                | SQUARE STOP 1/2" FACE WIDTH |
| <b>SINGLE GLAZED DOOR</b> |                             |
| 23.8mm GLASS UNIT         |                             |
| <b>DOUBLE GLAZED DOOR</b> | SQUARE STOP 3/4" FACE WIDTH |

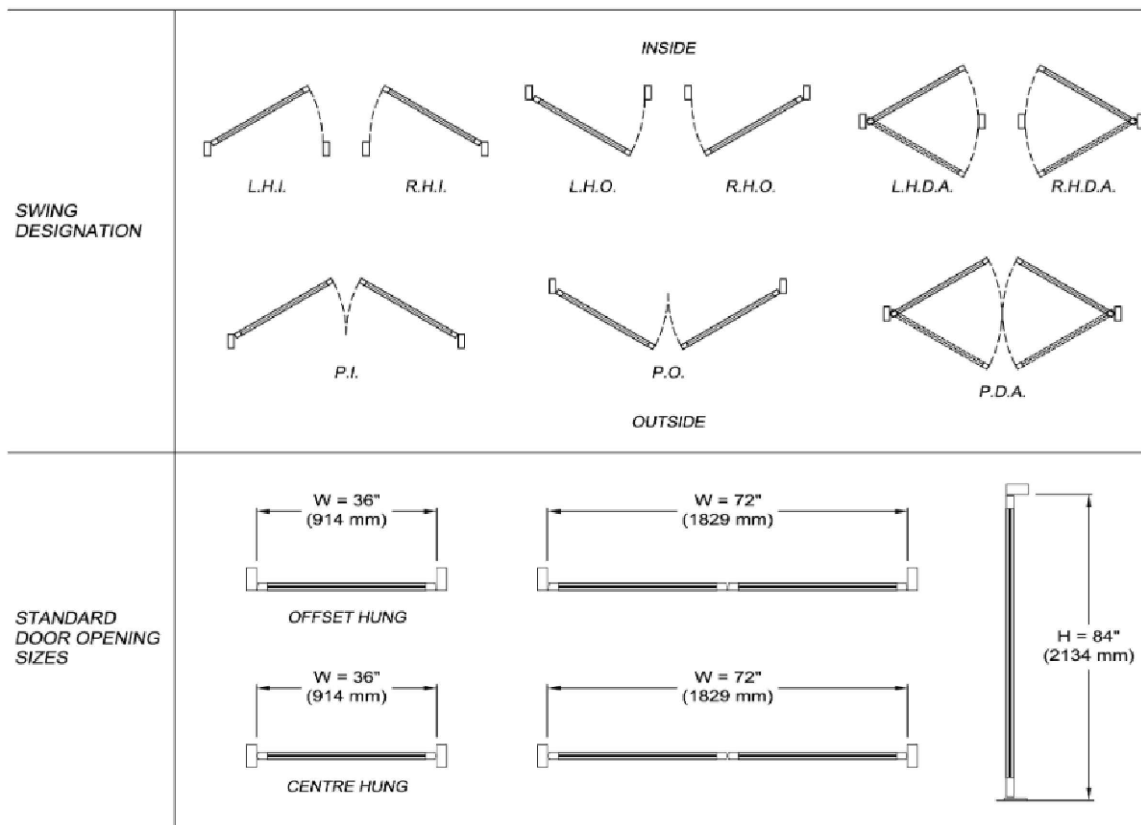

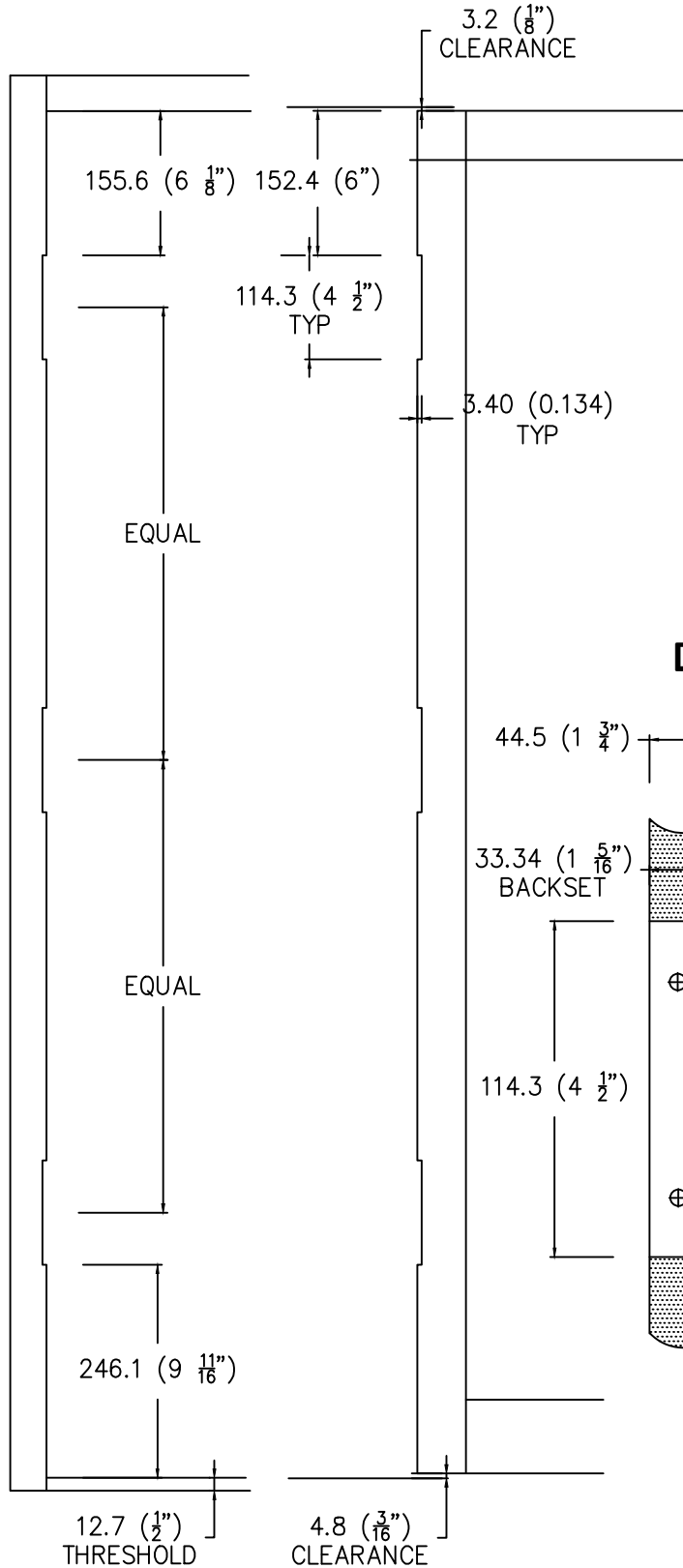

**STANDARD BUTT LOCATIONS**

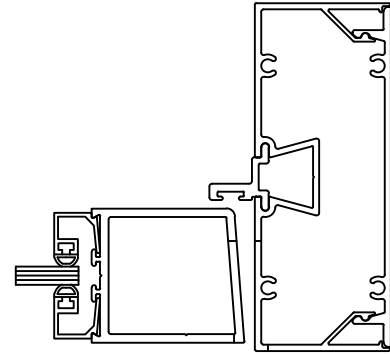

3.40 (0.134) ±

**DOOR**

**FRAME**

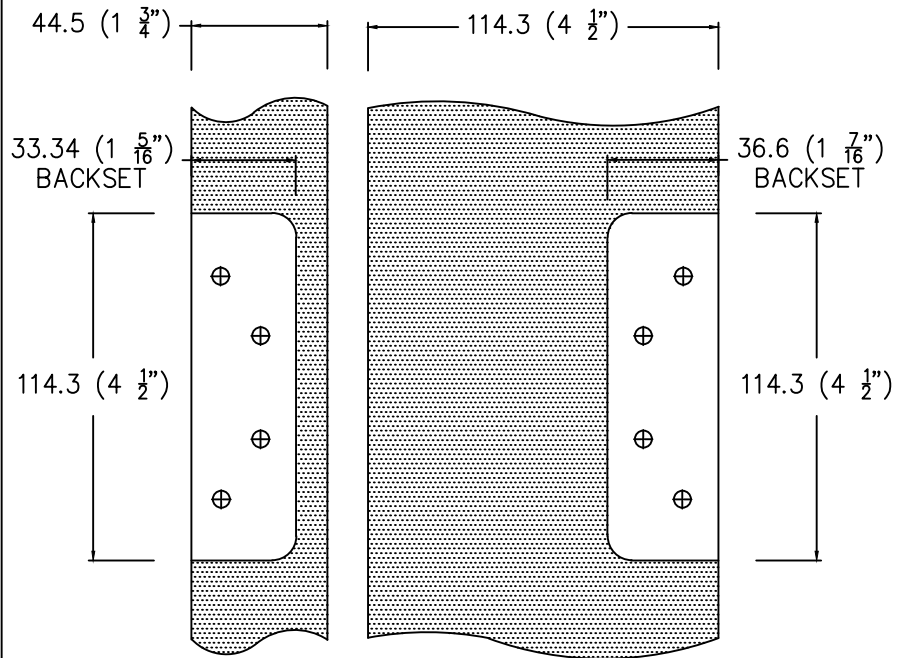

**FRAME**

**DOOR**

**INSTALLATION DETAILS**

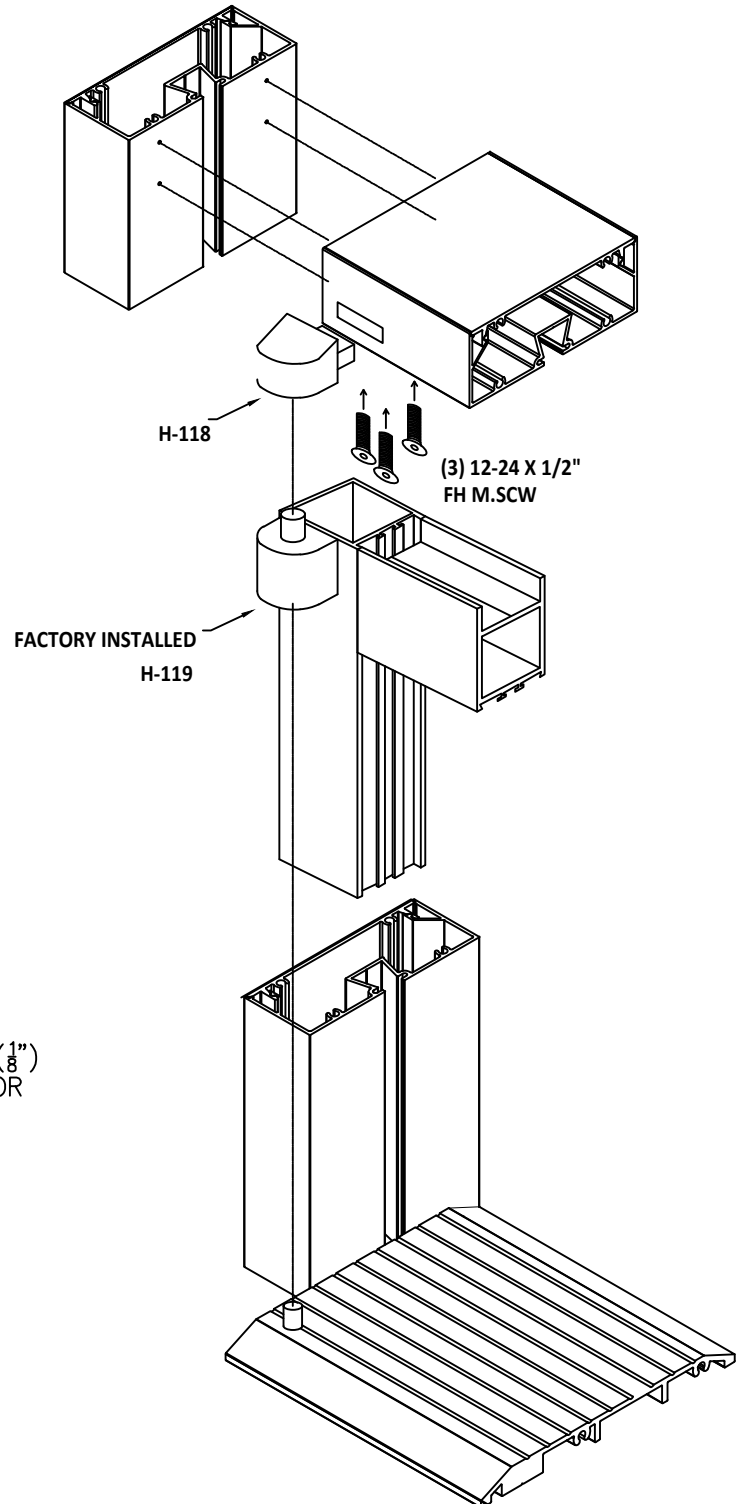
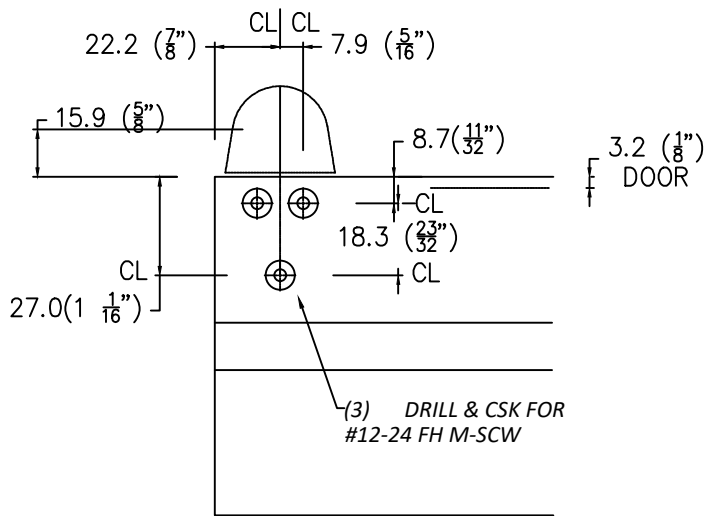
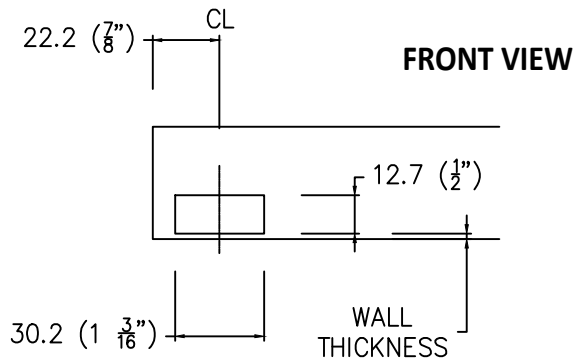



**H-100A**  
M.S DEAD LOCK



**H-102A**  
HOOK LOCK



**H-104A**  
LATCH LOCK



**H-104AR**  
A.R LATCH LOCK



**H-114/H-115**  
KEYED CYLINDER & THUMB TURN

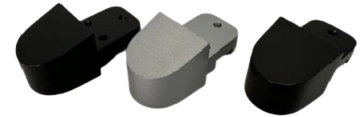

**H-118**  
FRAME PORTION PIVOT

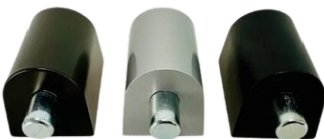

**H-119**  
TOP DOOR PORTION PIVOT

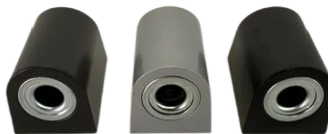

**H-120**  
BOTTOM DOOR PORTION PIVOT



**H-121**  
THRESHOLD PIN



**H-121F**  
FLOOR MOUNTED PIVOT



**H-250-1**  
METRO STANDARD PULL HANDLE



**H-250-2**  
METRO STANDARD PUSH BAR



**H-250-5**  
12" OFFSET D-PULL



**H-250-5/H-250-5P**  
OFFSET D-PULL & TUBULAR PUSH BAR



**H-250-6**  
12" B/B D-PULLS



**H-250-5GLP S.S**  
72" X 1 1/4" OFFSET LADDER PULL



**H-250-6GLP S.S**  
72" X 1 1/4" B/B OFFSET LADDER PULL



**H-122**  
4" X 4 1/2" BUTT HINGE S.S



**H-122 BP**  
4" X 4 1/2" BUTT HINGE BLACK



**H-122 PKG**  
BUTT HINGE WITH BACK UP PLATES



**H-122E**  
4 WIRE BUTT HINGE S.S



**H-123A**  
4 1/2" X 4 1/2" BUTT HINGE S.S



**H-124D**  
BUTT HINGE DOOR BACK UP PLATE



**H-124F**  
BUTT HINGE FRAME BACK UP PLATE



**H-130**  
METRO STANDARD CLOSER



**H-130X**  
STANDARD CLOSER ARM EXTENSION



**H-130A DR**  
STANDARD CLOSER DROP PLATE



**H-130 DA**  
DELAYED ACTION CLOSER



**H-128**  
GLOBAL TC204 CLASS 1 CLOSER



**H-1300P**  
PARALLEL ARM BRACKET



**H-4040**  
GLOBAL 4040 CLOSER



**H-4040-18G**  
GLOBAL 4040 CLOSER DROP PLATE



**H-4040-18PA**  
GLOBAL PARALLEL ARM DROP PLATE



**H-4040LA**  
4040 CLOSER ARM EXTENSION



**H-4040XLA**  
4040 CLOSER XL ARM EXTENSION



**H-4040 HOA**  
4040 CLOSER HOLD OPEN ARM



**H-158/H-159/H-160**  
CONTINUOUS HINGE



**H-103AR**  
A.R DUAL FORCE 2190



**H-100EI**  
EXIT INDICATOR



**H-104RL**  
ROLLER LATCH



**1550**  
S/G LETTER SLOT



**1555**  
INSULATED LETTER SLOT



**H-112**  
LEVER HANDLE

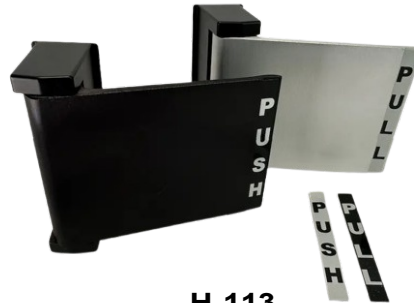

**H-113**  
LATCH PADDLE



**H-108P/H-108S**  
ELECTRIC STRIKES



**H-110**  
RECTIFIER



**H-111**  
ELECTRICAL CONNECTORS



**H-104S**  
G.J HEAVY DUTY DOOR CLOSER



**H-107**  
LATCH LOCK STRIKE



**H-107A**  
LATCH DOUBLE STRIKE



**H-106**  
CYLINDER GUARD



**H-114A**  
GMS R-118 RIM CYLINDER



**H-114B**  
KEY CYLINDER 1 1/8"



**H-114E**  
2 1/4" SPINDLE EXTENSION KIT



**H-116**  
BLACK CYLINDER



**H-117**  
FLUSH BOLTS



**H-126**  
INTERMEDIATE PIVOT



**H-126/H-127**  
WALKING BEAM PIVOT SET



**H-EPT2**  
A.R POWER TRANSFER



**H-137A/B/C**  
ASTRAGAL



**H-135**  
A.R 8400 PANIC



**H-135S**  
8400 PANIC STRIKE



**H-135X**  
8400 PANIC EXTENSION FOR 2" DOORS



**H-136**  
A.R 8600 PANIC



**H-136B**  
8600 PANIC STRIKE



**H-136X**  
8600 PANIC EXTENSION FOR 2" DOORS



**H-136**  
PS-LR POWER SUPPLY



**H-136A**  
CYLINDER MOUNTING PAD



**H-148 S.S**  
G.J SURFACE MOUNTED DOOR STOP



**H-131**  
CONCEALED CLOSER



**H-132**  
CENTER HUNG SIDE LOAD ARM



**H-105**  
COVER PLATES



**H-096**

HOPPE HANDLE SET - EXTERIOR



**H-096**

HOPPE HANDLE SET - INTERIOR

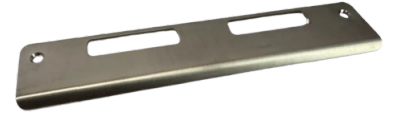

**H-096AS**

HOPPE LOCK STRIKE



**H-096HA**

GLOBAL ACTIVE HANDLE SET